

12

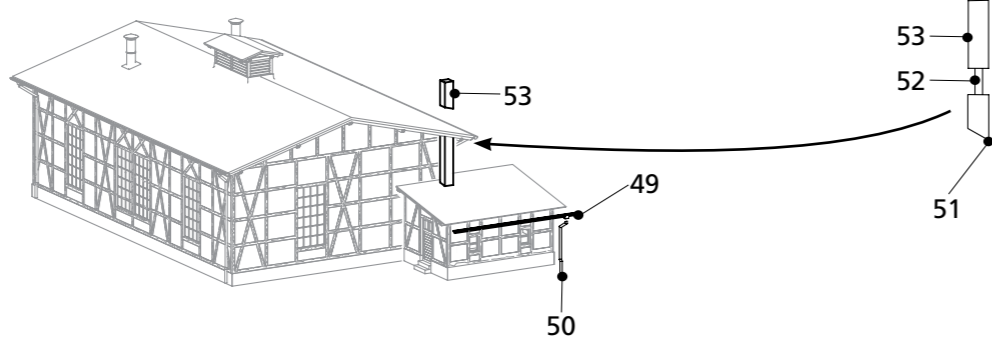

Mit einem zweiten Bausatz ist unser Art. 11 403 Lokschuppen zweiständig zum Wagen- bzw. Triebwagenschuppen verlängerbar.

TIPPS:

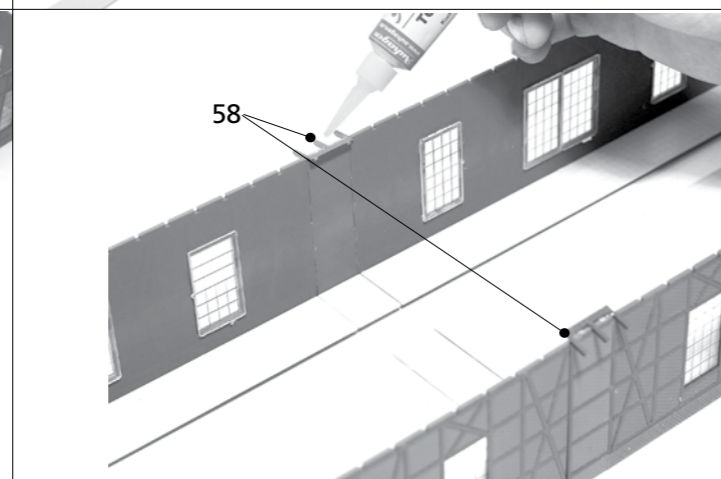
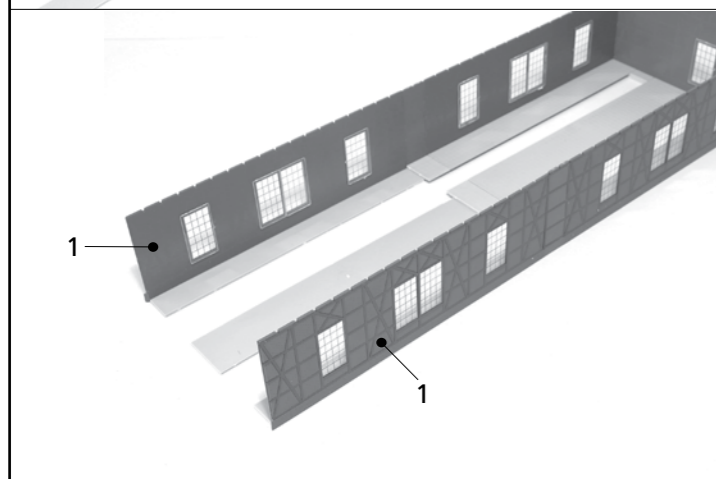
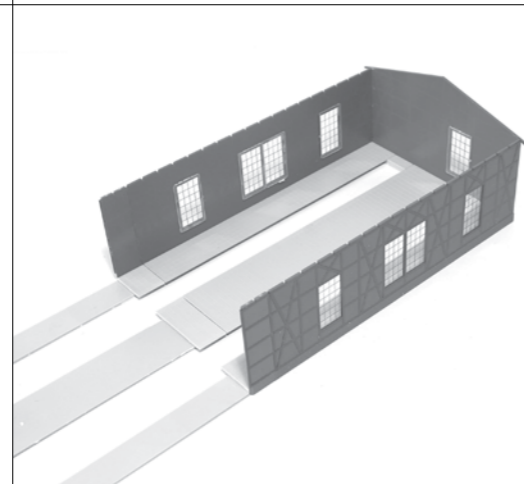
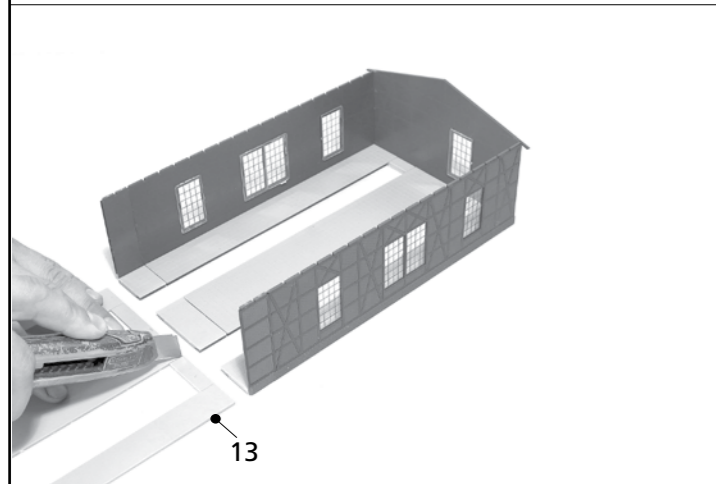
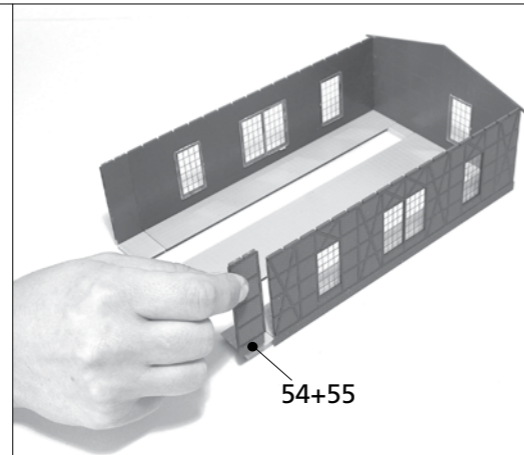
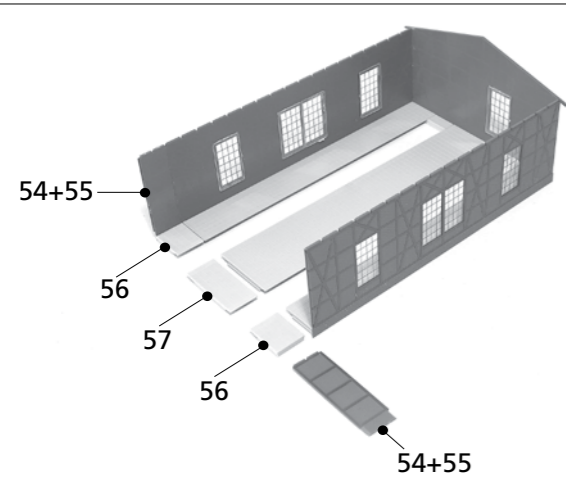

H0

11 403

Lokschuppen zweiständig

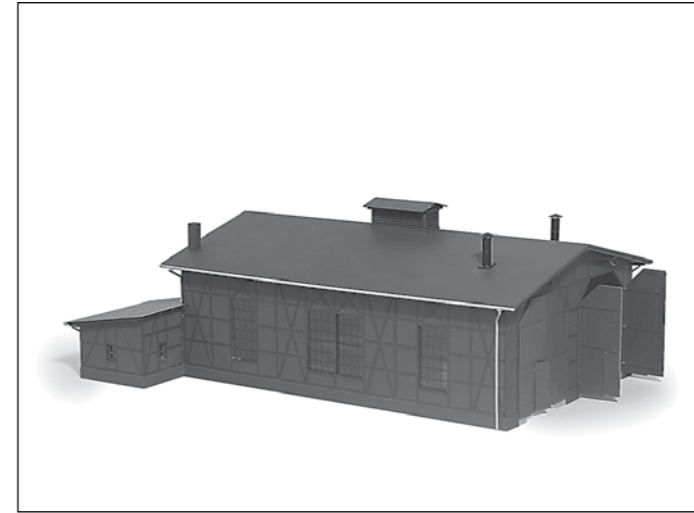

Vorderseite

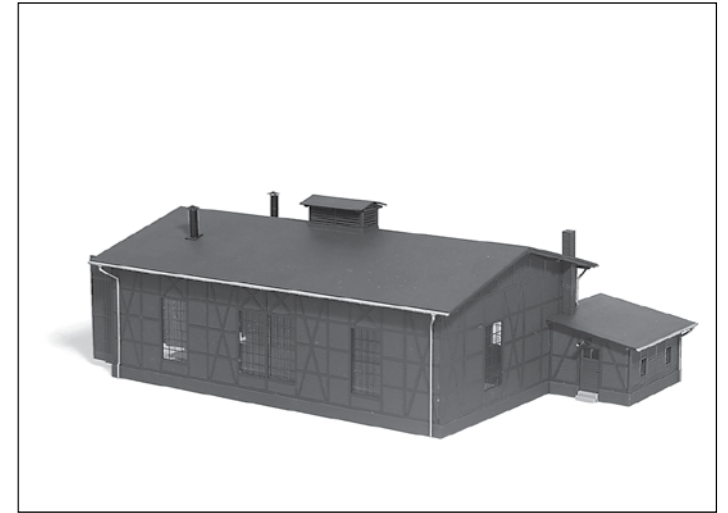

Rückseite

- DE** Dieser Bausatz wurde sorgfältig gepackt und geprüft. Trotzdem kann ein Teil fehlen oder fehlerhaft sein. Bitte teilen Sie uns dann Artikel-Nummer und Bezeichnung dieses Bausatzes sowie die Positions-Nummer des betreffenden Teiles mit. Ersatz wird kostenlos nachgeliefert. Die nummerierten Teile werden entsprechend der Bauanleitung zusammengefügt. Bitte benutzen Sie Kleber, der sich für Polystyrol eignet.
- AT** Vorschläge, Hinweise und Empfehlungen zu unseren Bausätzen sind uns jederzeit willkommen. Gegen Gebühr können Sie unseren Katalog anfordern.
- CH** This assembly kit has been carefully examined and packaged. It may still be possible that a part is missing or defective. In such case, please let us have the article number and the designation of this assembly kit as well as the item number of the part concerned. We shall immediately replace it. The numbered parts are assembled in accordance with the assembly instructions. Please use adhesive that is suitable for polystyrene. Improvement suggestions and recommendations concerning our assembly kits are always welcome. Our catalogue is available for a fee.
- FR** Ce kit a été soigneusement conditionné et vérifié. Il peut toutefois arriver qu'une pièce manque ou soit défectueuse. Indiquez-nous s.v.p. le numéro de référence et le nom de ce kit ainsi que le numéro de position de la pièce concernée. La pièce de remplacement vous sera livrée gratuitement. L'assemblage des pièces numérotées a lieu conformément à la notice d'instructions. Veuillez utiliser une colle adaptée au polystyrène. Faites nous part de vos préconisations, conseils et recommandations relatifs à nos kits de maquettes, ils sont en permanence les bienvenus. Vous pouvez demander notre catalogue contre réglemt.
- BE** La pièce de remplacement vous sera livrée gratuitement.
- SE** Denna byggsatt har förpackats och testats noggrant. Likväl kan en del fattas eller vara defekt. Var vänlig meddela oss så fall byggsattens artikelnummer och beteckning samt frågavarannde dels positionsnummer. En ersättning levereras gratis. De numerade delarna sätts ihop i enlighet med instruktionen. Var vänlig använd lim som lämpar sig för polystyren. Vi tar alltid gärna emot förslag, tips och rekommendationer vad gäller våra byggsatser. Mot en avgift kan du beställa vår katalog.
- NO** Dette byggesettet ble omhyggelig pakket og kontrollert. Det kan likevel mangle en del eller være mangelfullt. Vær vennlig å meddele oss så produktnummeret og betegnelsen til dette byggesettet samt positionsnummeret til den tilsvarende delen. Vi etterleverer erstatning uten kostnader. De numererte delene settes sammen i henhold til byggeveiledningen. Benytt et lim som er egnet for polystyrol. Forslag, henvisninger og anbefalinger til våre byggesett er til enhver tid velkomne. Du kan bestille katalogen vår mot et gebyr.
- RO** Acest set constructiv a fost ambalat și verificat cu atenție. Totuși poate să lipsească o piesă sau să fie defectă. Vă rugăm să ne comunicați în acest caz numărul articolului și denumirea acestui set constructiv precum și numărul de poziție al piesei respective. Se va livra ulterior gratuit o piesă înlocuitoare. Piese numerotate sunt asamblate conform instrucțiunilor de construcție. Vă rugăm să utilizați un adeziv, care este adecvat pentru polistiren. Sfaturi, indicații și recomandări în privința seturilor noastre constructive sunt întotdeauna bine-venite. Contra unui taxă puteți solicita catalogul nostru.
- SI** Ta gradbeni komplet je bil skrbno preverjen in zapakiran. Kljub temu lahko manjka oz. je poškodovan kakšen sestavni del. V tem primeru nam sporočite številko izdelka in oznako gradbenega kompleta ter številko položaja manjkajočega/poškodovanega dela. Nadomestni del vam bomo poslali brezplačno. Oštevilčene dele sestavite glede na gradbeno navodila. Uporabljajte le lepilo, ki so primerna za polistrol. Vedno so dobrodošli predlogi, napotki in priporočila glede naših gradbenih kompleto. Proti plačilu pa lahko naročite naš katalog.
- TR** Bu malzeme düzgünce paketlenmiştir ve kontrol edilmiştir. Buna rağmen bir parçası eksik veya hatalı olabilir. Bu durumdaki bir parçanın numarasını ve adını ve de ilgili parçanın pozisyon numarasını bildiriniz. Yedek parçalar ücretsiz olarak gönderilir. Numaralandırılmış olan parçalar montaj kılavuzuna göre birleştirilir. Lütfen polistirene uygun bir yapıştırıcı kullanınız. Malzemelerimize ilişkin öneriler, bilgiler ve tavsiyeleri her zaman hoş karşılarız. Katalogumuza ücret karşılığında talep edebilirsiniz.
- HR** Ovak komplet za gradnju je brižljivo pakiran i provjeren. Unatoč tomu može nedostajati neki dio. Molimo Vas da nam javite broj artikla i naziv kompleta za gradnju kao i broj pozicije dotičnog dijela. Zamjenjki dio će biti besplatno isporučen. Numerirani dijelovi se spajaju zajedno prema uputstvu za gradnju. Molimo upotrebljavati ljepilo koje je prikladno za polistrol. Preporuke, prijedlozi i savjeti za naše komplete za gradnju su dobrodošli u svako doba. Naš katalog možete zatražiti uz plaćanje naknade.
- RU** Этот комплект был тщательно проверен и упакован. Тем ни менее, какой-либо детали может не хватать, или одна из деталей может быть повреждена. В этом случае сообщите нам, пожалуйста, номер артикула и наименования комплекта, а также позиционный номер соответствующей детали. Мы поставим Вам бесплатно замену. Нумерованные детали собираются в соответствии с инструкцией по сборке. Используйте клей для полистирола. Если у Вас есть предложения, советы и рекомендации, то мы с удовольствием примем их. За дополнительную плату Вы можете заказать наш каталог.
- UA** Моля, просьчете ни номера на артикула и обозначенето на този комплект, както и позиционния номер на съответната част. Замяната ще бъде извършена от нас безплатно. Номерираните части се съглобяват в съответствие с ръководството за съглобяване. Моля, използвайте лепило, което е подходящо за полистирол. Изпращайте ни по всяко време предложения, указания и препоръки във връзка с нашите модели. Срещу заплащане можете да си поръчате нашия каталог.
- BG** Този комплект е внимателно опакован и проверен. Въпреки това е възможно някоя част да липсва или да е дефектна. Моля, просьчете ни номера на артикула и обозначенето на този комплект, както и позиционния номер на съответната част. Замяната ще бъде извършена от нас безплатно. Номерираните части се съглобяват в съответствие с ръководството за съглобяване. Моля, използвайте лепило, което е подходящо за полистирол. Изпращайте ни по всяко време предложения, указания и препоръки във връзка с нашите модели. Срещу заплащане можете да си поръчате нашия каталог.
- PT** Este kit foi embalado e controlado com acurácia. Não obstante pode faltar uma peça ou ela pode apresentar uma falha. Nesse caso é favor indicar-nos o número de artigo e a designação deste kit e ainda o número de posição da peça em questão. Uma peça de reposição será enviada gratuitamente. As peças numeradas são unidas conforme descrito na instrução de montagem. É favor usar uma cola adequada para poliestireno. Aceitamos de bom grado sugestões, indicações e recomendações relativas aos nossos kits. Pode encenar o nosso catálogo, pagando uma taxa.
- IT** Questo kit per il modellismo è stato confezionato e controllato con cura. Ma nonostante tutto potrebbe mancare oppure essere difettoso un componente. Vi preghiamo di comunicarci il codice e la denominazione del kit come pure il numero di posizione del pezzo mancante. Provvederemo ad una sostituzione gratuita. I pezzi numerati verranno assemblati seguendo le istruzioni per il montaggio. Vi preghiamo di voler utilizzare una colla per il polistirolo. Accettiamo con piacere eventuali proposte, indicazioni e consigli in merito ai nostri kit da montare. È possibile richieder il nostro catalogo dietro pagamento di un contributo per le spese.
- NL** Deze bouwset werd zorgvuldig verpakt en gecontroleerd. Niettemin kan er een deel ontbreken of fouten bevatten. Gelieve ons dan artikelnummer en benaming van deze bouwset en het positionnummer van het betreffende deel mee te delen. Vervanging wordt kosteloos nageleverd. De genummerde delen worden overeenkomstig de bouwhandleiding ineengezet. Gelieve voor polystyreen geschikte stickers te gebruiken. Voorstellen, aanwijzingen en aanbevelingen bij onze bouwsets zijn altijd welkom. Tegen vergoeding kunt u onze catalogus aanvragen.
- BE** De nummerere dele samles i henhold til byggevejledningen. Anvend lim til polystyrenholdige materialer. Vi modtager gerne forslag, tips og anbefalinger vedrørende vores byggesæt. Vores katalog kan bestilles mod betaling.
- DK** Byggesættet er omhyggeligt emballeret og kontrolleret. Skulle pakken dog alligevel indeholde mangelfulde dele eller helt manglende dele: Oplys artikelnummer og byggesættets navn samt delens placeringsnummer. Deretter fremsendes reservedelen gratis. De nummererede dele samles i henhold til byggevejledningen. Anvend lim til polystyrenholdige materialer. Vi modtager gerne forslag, tips og anbefalinger vedrørende vores byggesæt. Vores katalog kan bestilles mod betaling.
- FI** Tämä mallisarja on pakattu ja tarkastettu huolellisesti. Siitä huolimatta osa voi puuttua tai olla viallinen. Ilmoita meille silloin tämän mallisarjan tuotenumero ja nimike sekä kyseisen osan numero. Varaosa toimitetaan ilmaiseksi. Numeroidut osat kootaan kokoonpano-ohjeen mukaan. Käytä liimaa, joka soveltuu polystyreenille. Otamme mielellämme vastaan mallisarjojamme koskevia ehdotuksia, huomautuksia ja suosituksia. Voit tilata luettelomme maksua vastaan.

Auhagen

Auhagen GmbH
OT Hüttengrund 25
D-09496 Marienberg/Erzgeb.
Fon: +49 (0) 3735 668466
info@auhagen.de

10/2012/A/5

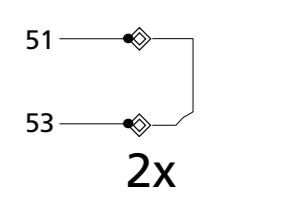
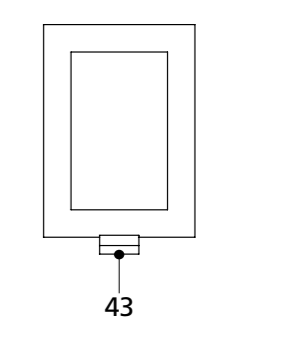
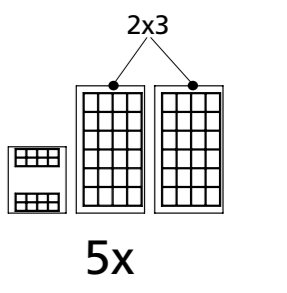
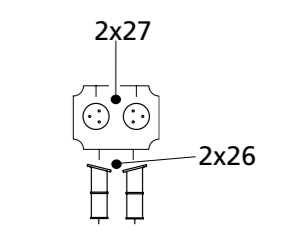
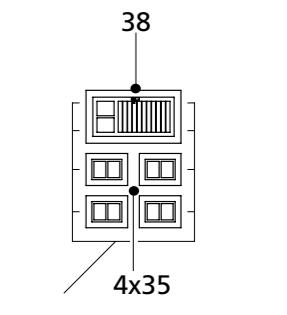
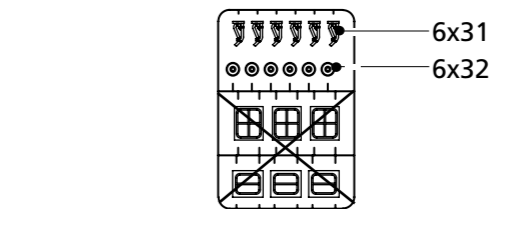
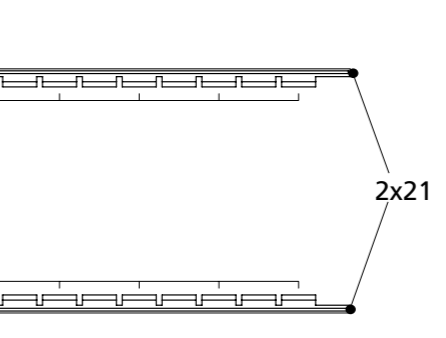
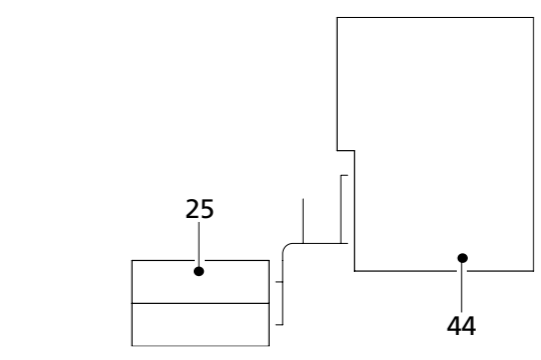
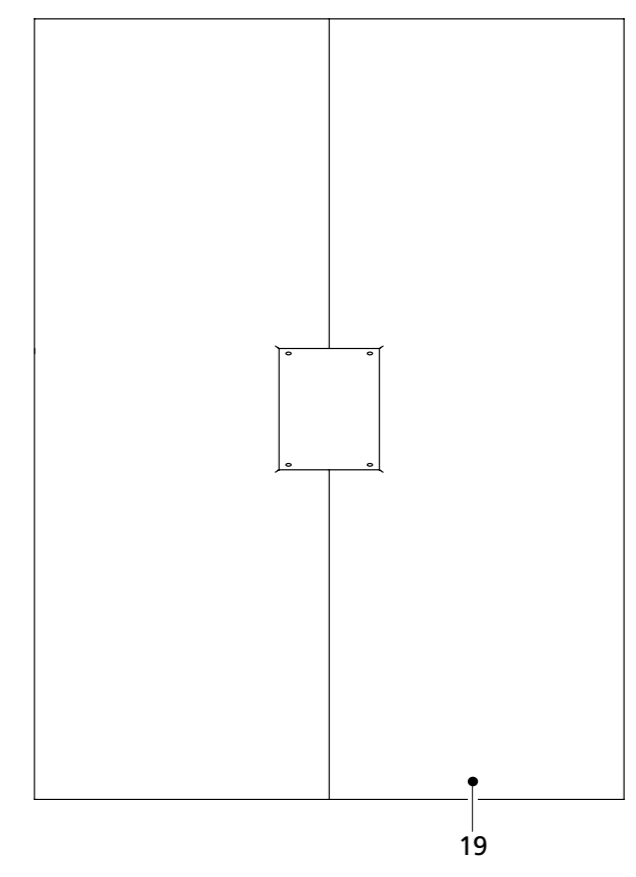
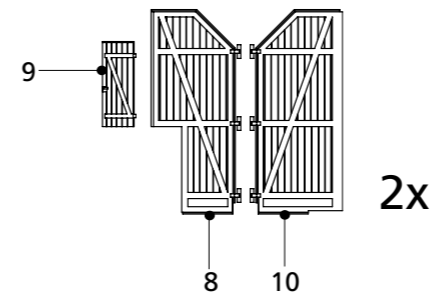
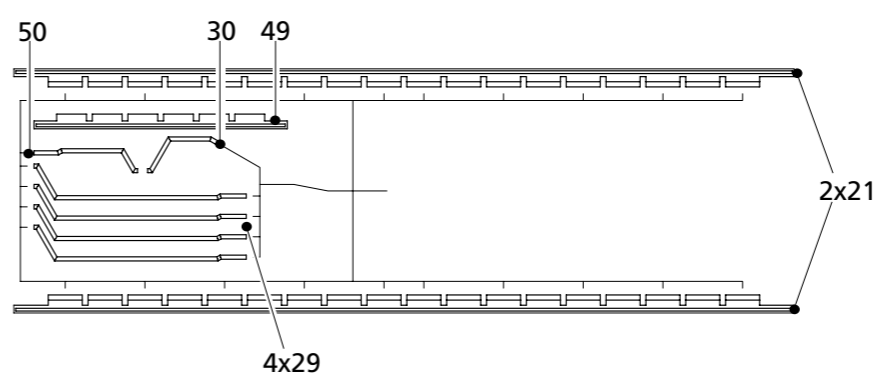
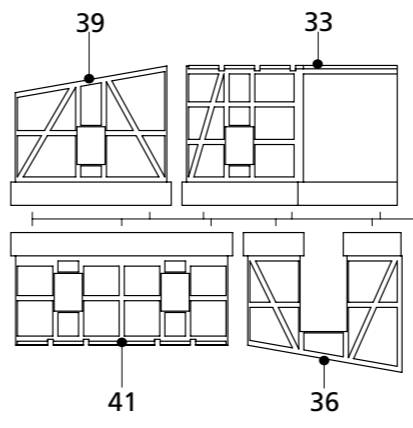
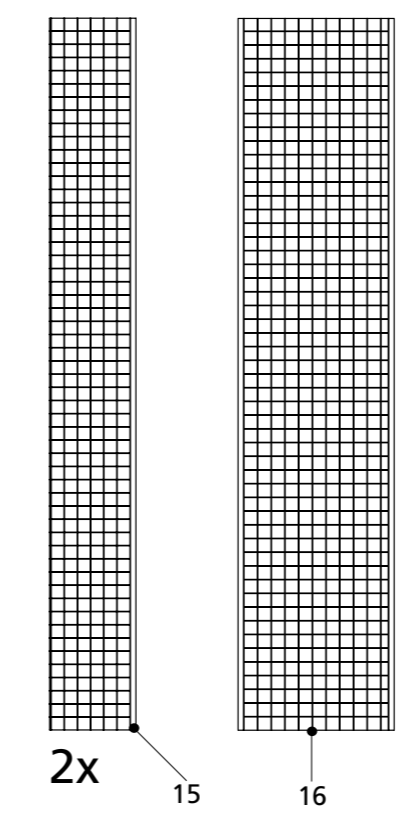
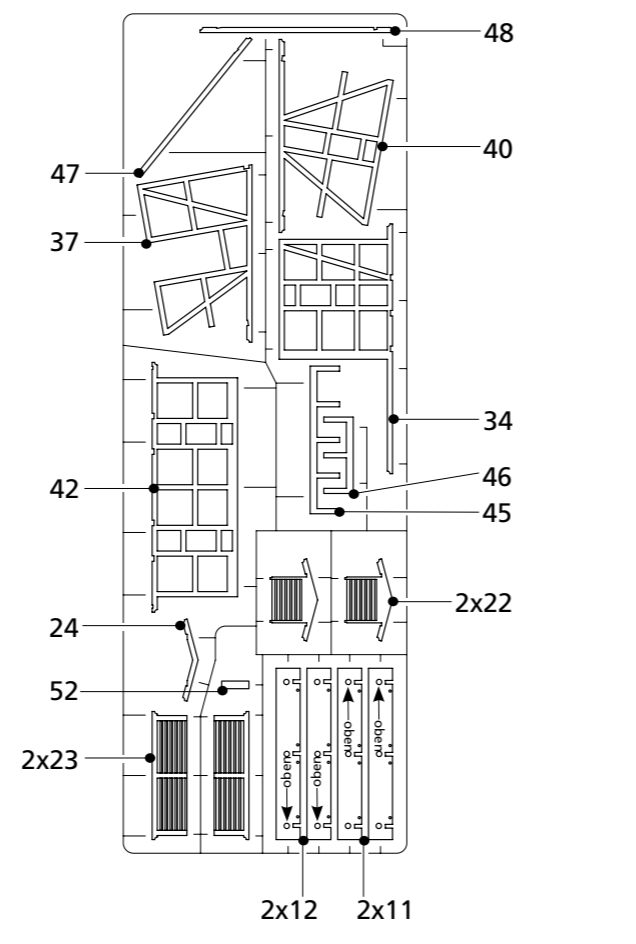
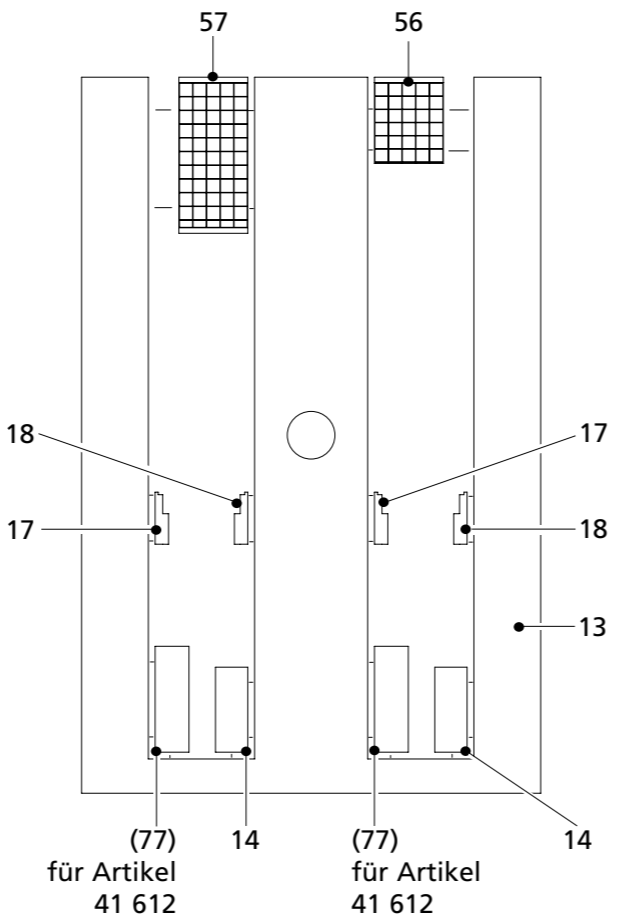
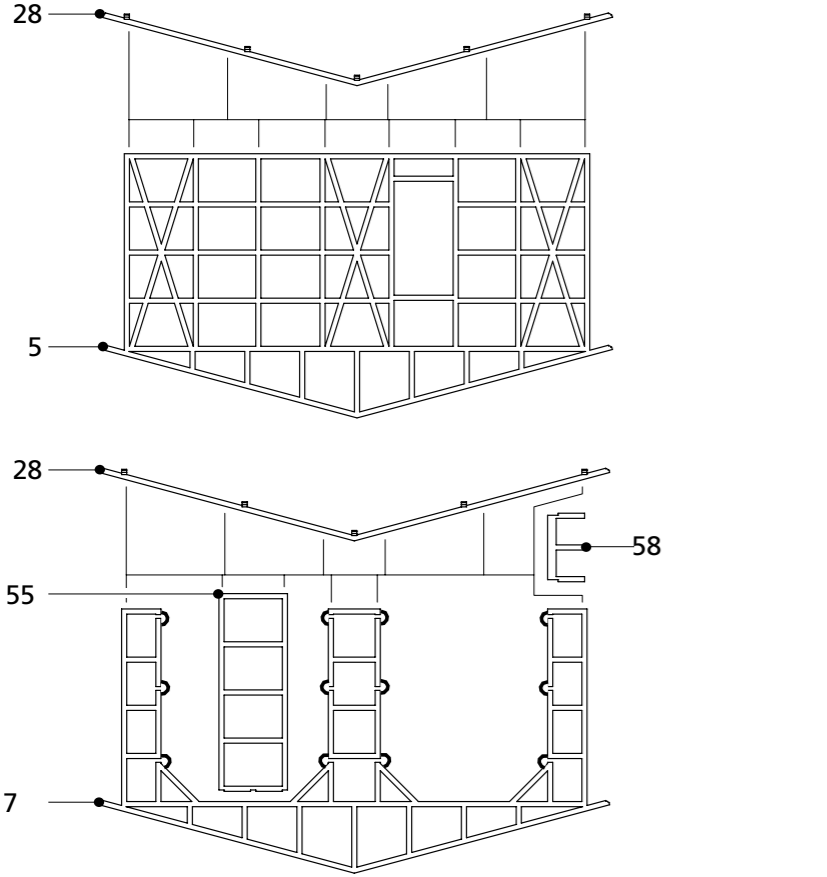
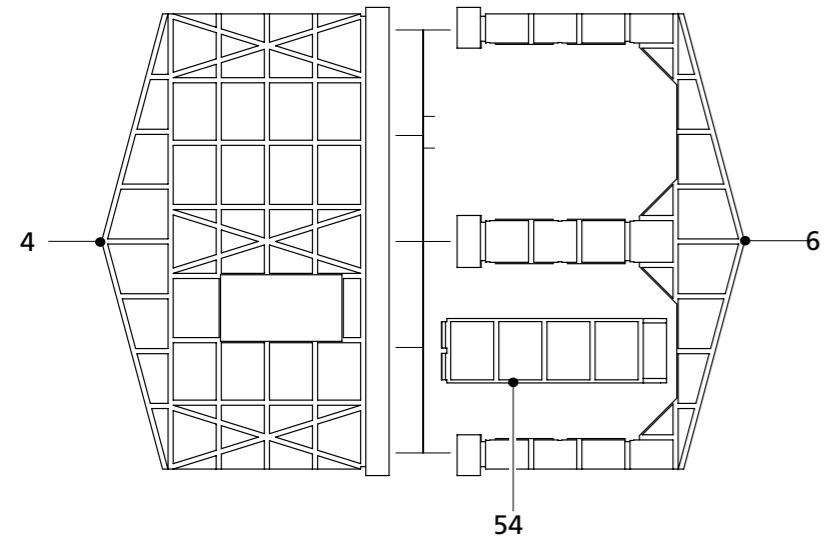
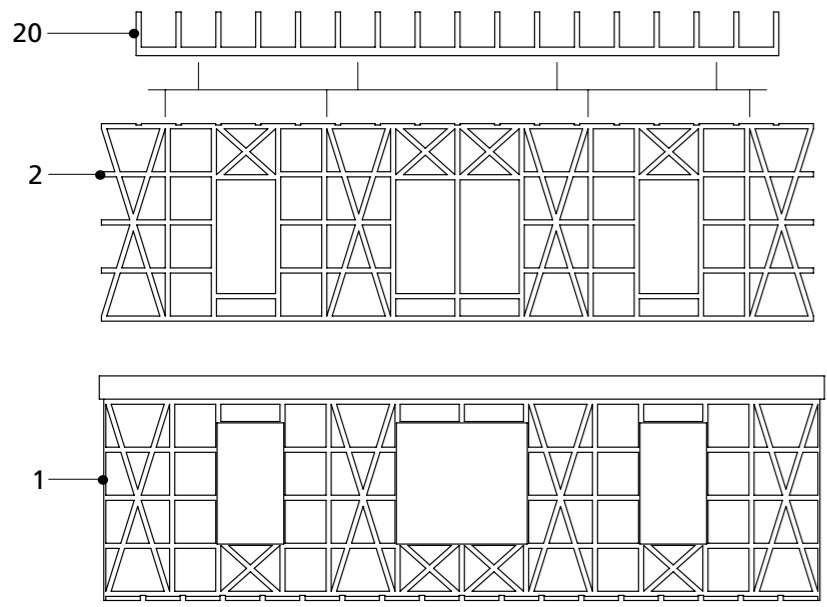

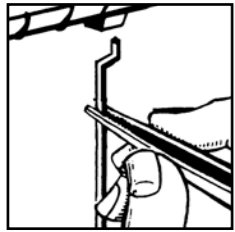
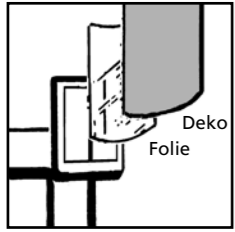
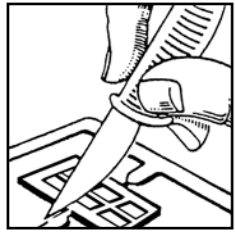

Ersatzteile
direkt bei
Auhagen GmbH!

Änderungen vorbehalten

Hinweis:
Erst Fachwerk,
dann Fenster einkleben!
Holzstruktur beachten!

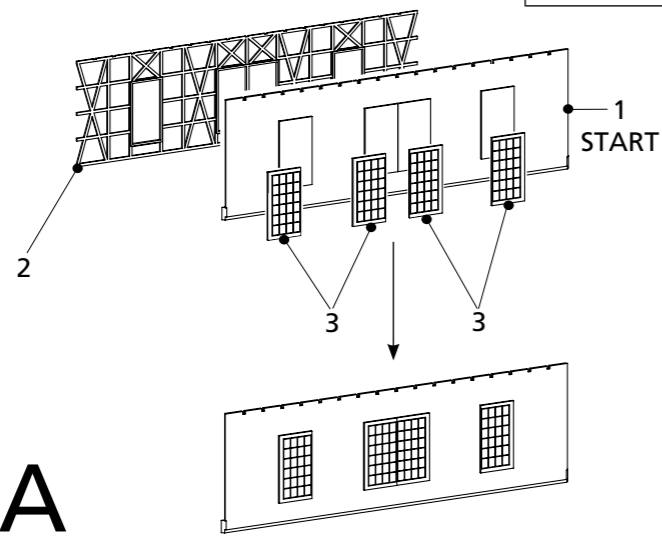
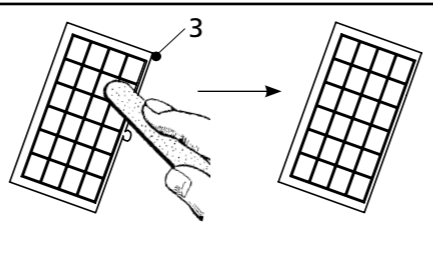

A

B

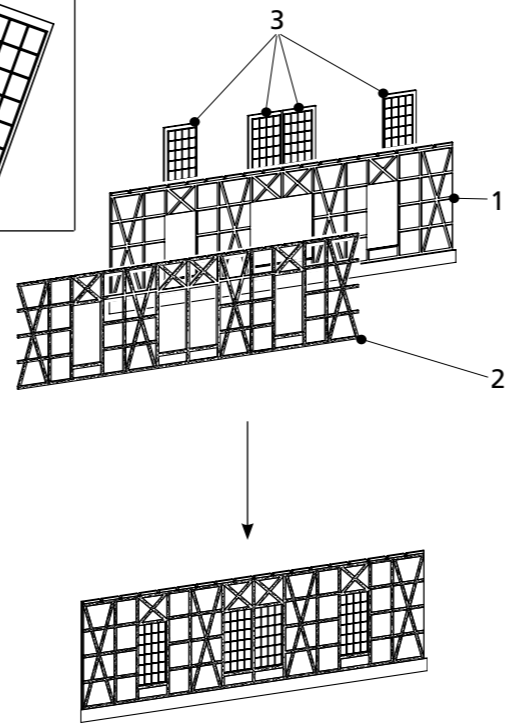

C

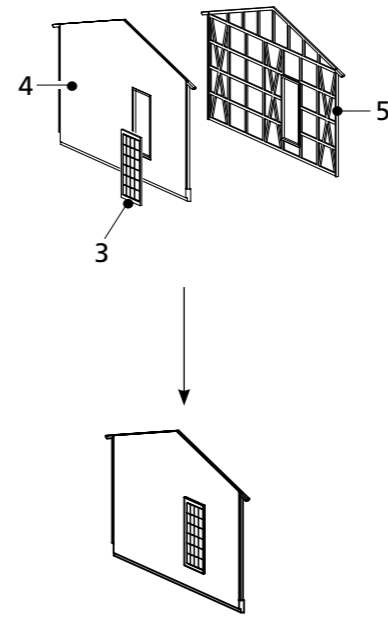

D

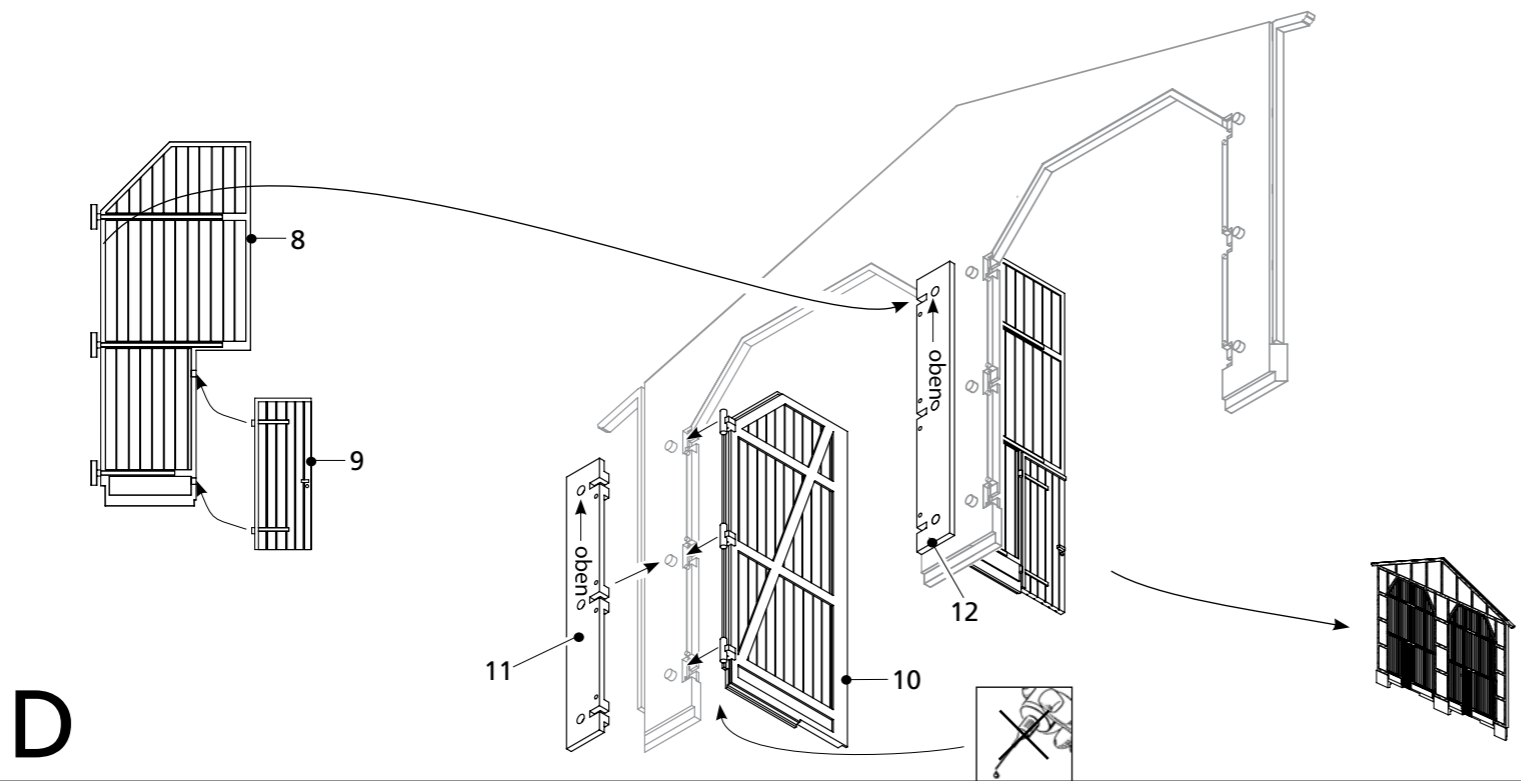
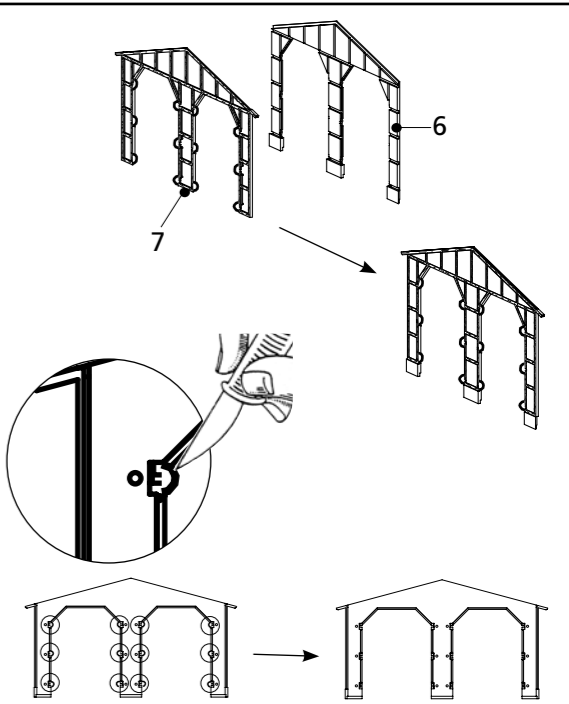

D

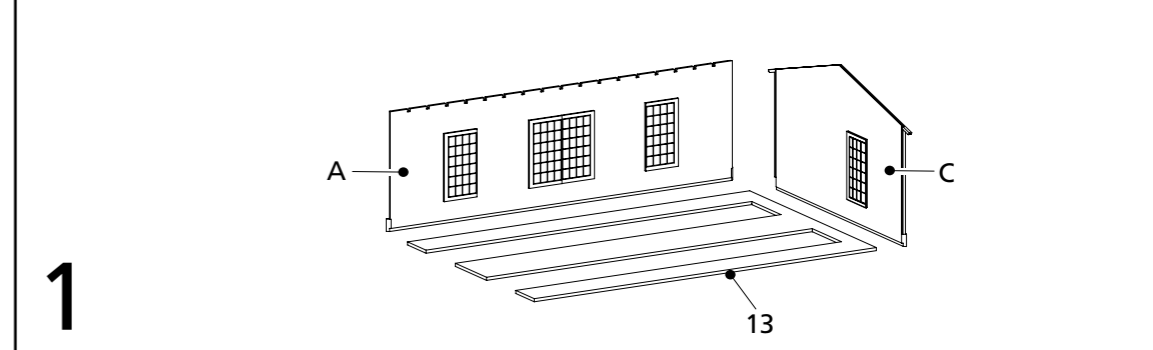

1

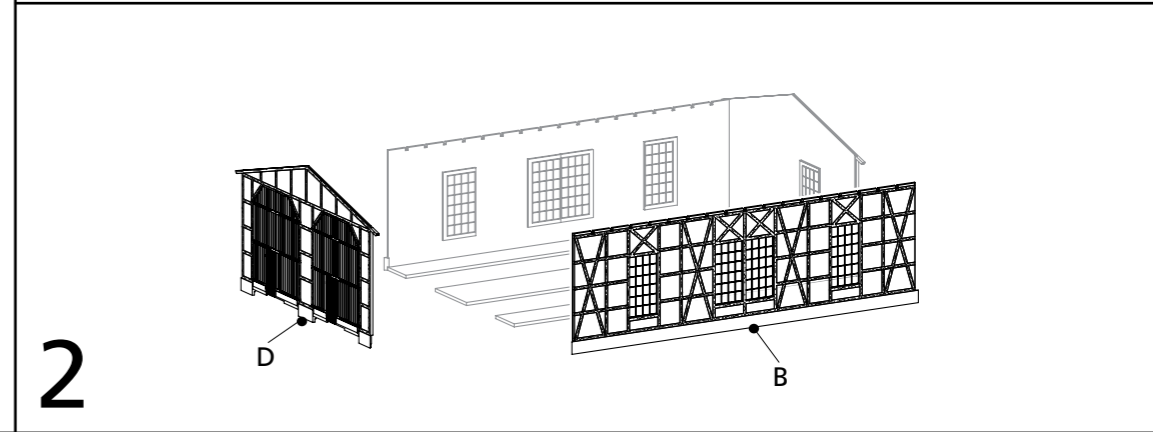

2



3

Hinweis: Gleis unbedingt vor Einbau der
Abdeckplatten zur Probe einlegen!

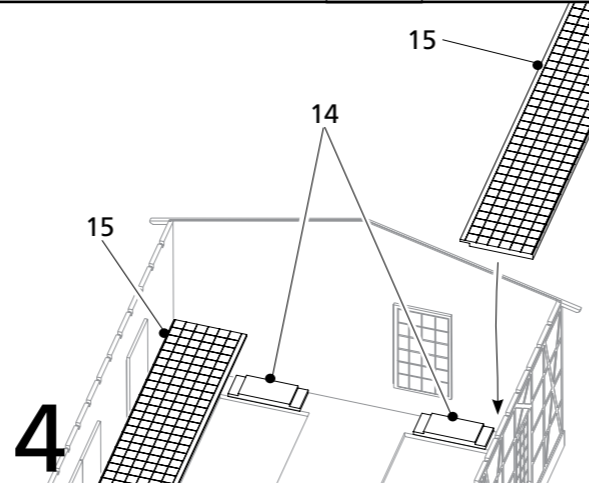

4

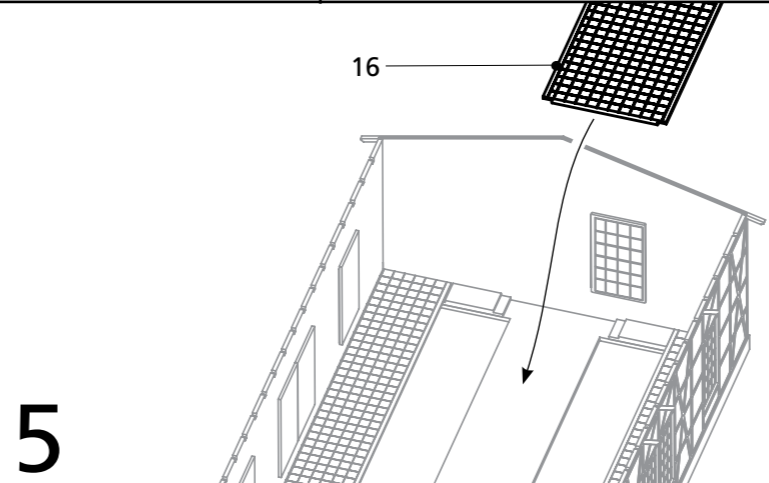

5

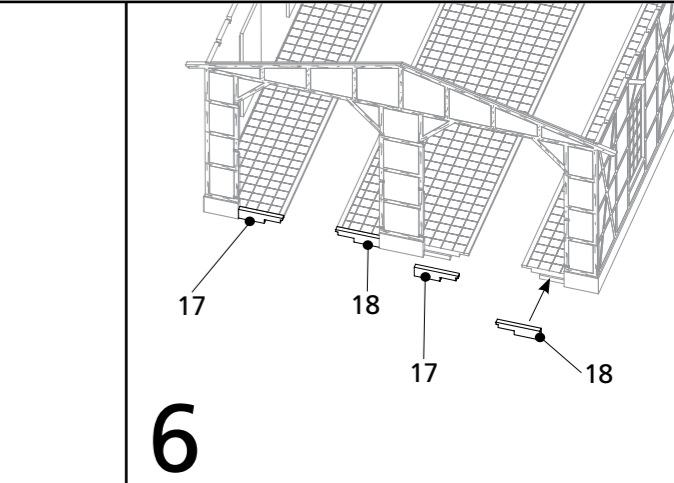

6

