

BAHNHOF »GÜGLINGEN«



»GÜGLINGEN« STATION
GARE DE »GÜGLINGEN«
STATION »GÜGLINGEN«

Art. Nr. 212107

D

Machen Sie sich bitte vor Beginn des Bastelns mit dem Bausatzinhalt und der Anleitung vertraut und prüfen Sie die Vollständigkeit. Im Reklamationsfall gilt die gesetzliche Gewährleistungspflicht. Sollte ein Teil fehlen, übersenden Sie bitte den Teilwunsch und den Kaufbeleg an: Gebr. FALLER GmbH, Kundendienst, Kreuzstraße 9, D-78148 Gütenbach, kundendienst@faller.de. Sollten Sie einmal weitere Ersatzteile benötigen, senden wir Ihnen den benötigten Spritzling, bei Verfügbarkeit, gerne kostenpflichtig zu. Bitte beachten Sie, dass produktionsbedingt Einzelteile übrig bleiben können.

GB

Before building your model, please familiarize yourself with the contents of the kit and the instructions for use, also checking whether the set of parts is complete. In case of any complaint, the legal guarantee obligation shall apply. Should a part be missing, please send the designation of the part required and the receipt documenting your purchase to: Gebr. FALLER GmbH, Kundendienst, Kreuzstraße 9, D-78148 Gütenbach, kundendienst@faller.de. Should you require further spare parts one day, we shall be pleased to send you, with costs, the required sprue, if it is available. Please note that, on grounds of the production process, some single injection molded parts may be superfluous.

F

Avant de commencer votre modèle, veuillez vous familiariser avec le contenu du kit et la notice d'emploi, et contrôlez que le lot de pièces est complet. En cas de réclamation, il s'appliquera l'obligation de garantie légale. Au cas où une pièce manquerait, veuillez envoyer la désignation de la pièce souhaitée et le bon d'achat à: Gebr. FALLER GmbH, Kundendienst, Kreuzstraße 9, D-78148 Gütenbach, kundendienst@faller.de. Au cas où vous auriez besoin un jour d'autres pièces détachées, nous vous enverrons volontiers la grappe requise, si elle est disponible, contre paiement. Veuillez noter que, pour des raisons de production, il se peut que des pièces détachées soient superflues.

NL

Maak uzelf vóór het bouwen vertrouwd met de inhoud van het bouwpakket en met de handleiding en controleer de volledigheid. In geval van reclamatie geldt de wettelijke garantieverplichting. Macht er een onderdeel ontbreken, stuur het verzoek om het gewenste onderdeel en het aankoopbewijs dan naar: Gebr. FALLER GmbH, klantenservice, Kreuzstraße 9, D-78148 Gütenbach, kundendienst@faller.de. Als u ooit meer reserveonderdelen nodig hebt, sturen wij het benodigde gietstuk, indien beschikbaar, graag tegen betaling naar u op. Let op: om productieredenen kunnen losse onderdelen overblijven.

Für den Zusammenbau des Modells empfehlen wir folgende FALLER-Artikel (sind nicht im Bausatz enthalten):

For the assembly of the kit we recommend following FALLER products (not included in the kit):

Pour l'assemblage du modèle, nous vous recommandons les articles FALLER suivants (non inclus dans le kit):

Om dit model te bouwen adviseren wij de volgende FALLER producten (maken geen deel uit van deze bouwset):

Art. Nr. 170492
FALLER-EXPERT

Flüssigkleber in Plastikflasche mit Spezialkanüle für feinste Klebstoffdosierung.

Liquid cement in plastic bottle with canule for very fine dosage.

Cette liquide en bouteille plastique avec bec verseur pour un dosage précis.

Vloeibare lijm in plastic-flescon met doseerbuisje om nauwkeurig te lijmen.



Art. Nr. 170688
SPEZIAL SEITENSCHNEIDER

zum geratfreien Abtrennen von feinsten Spritzteilen.
Nur für Polystyrol geeignet.

Special side cutter for cutting off ultra-fine moulded parts without burrs.
Only suitable for polystyrene.

Pince coupants spéciale pour couper sans bavure les pièces miniatures moulées par injection. Convient uniquement au polystyrène.

Speciale zijknijplang voor het burmloos afknippen van de fijnste gietstukdelen. Alleen geschikt voor polystyrol.

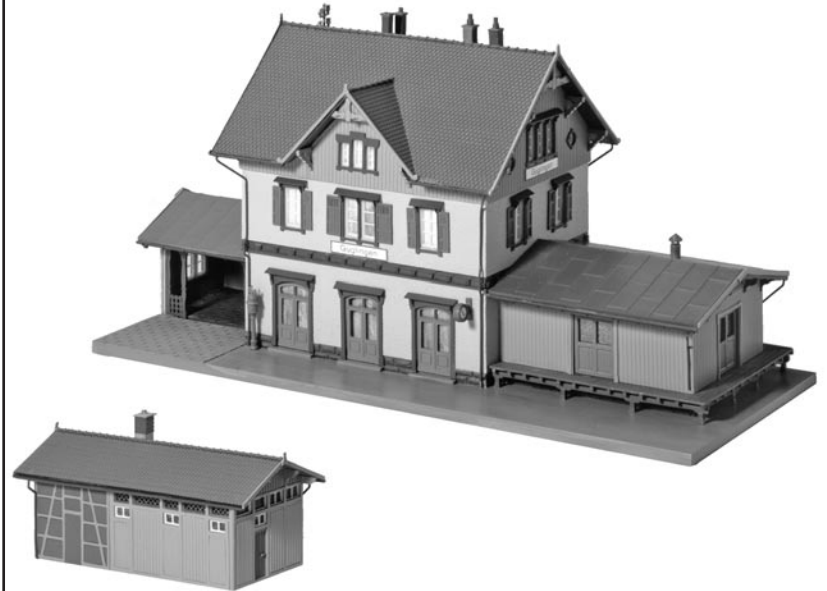



Inhalt	Spritzlinge	1	1 x	4	1 x	7	1 x	10	1 x	13	1 x
Contents	Sprues	2	1 x	5	1 x	8	1 x	11	1 x	14	1 x
Contenu	Moulages	3	1 x	6	1 x	9	1 x	12	1 x		
Inhoud	Gietstukken										

Sa. Nr. 213 985 0

2

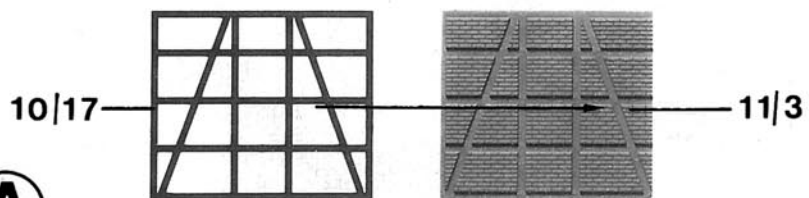
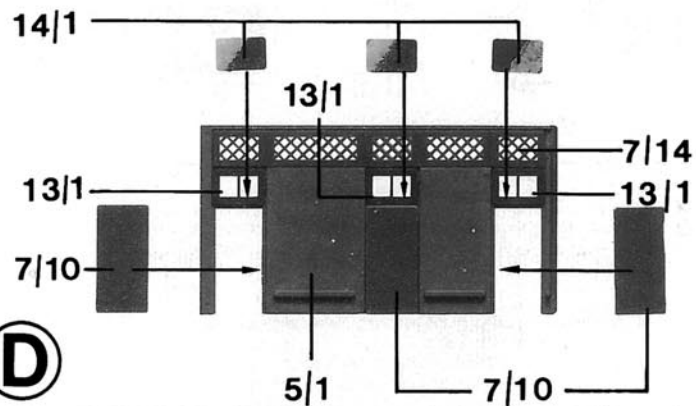
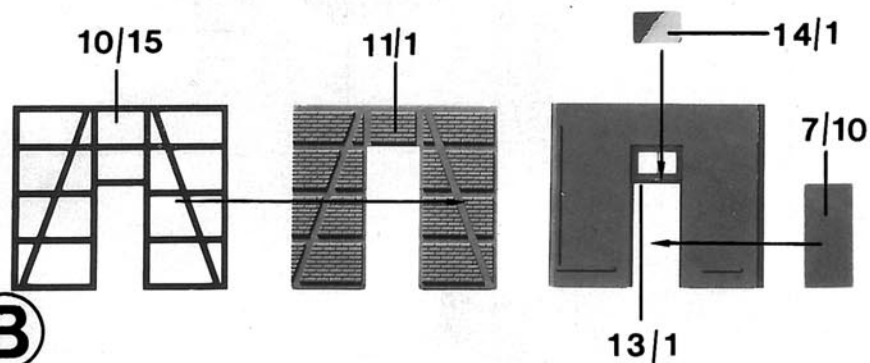
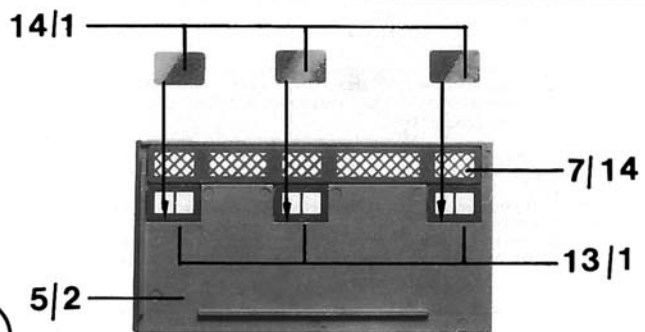
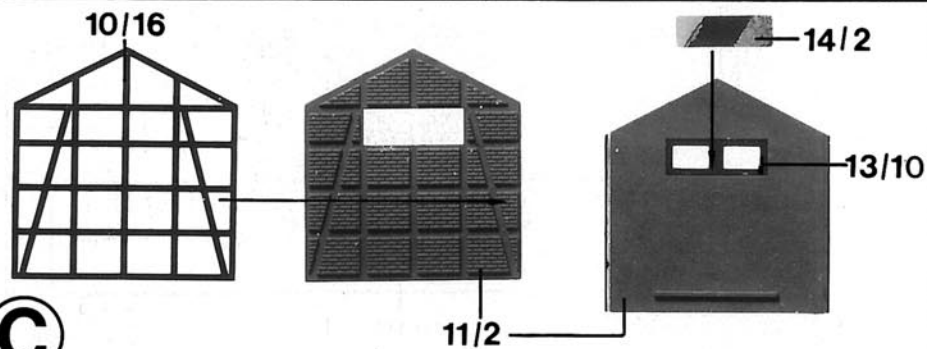
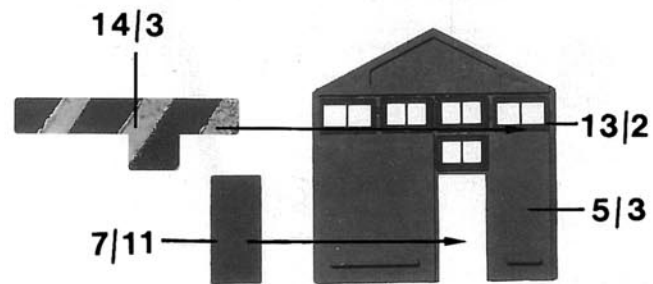
Spritzlinge	5	11
Sprues	7	13
Moulages	10	14
Gietstukken	10	14

**A****D****B****E****C****F**

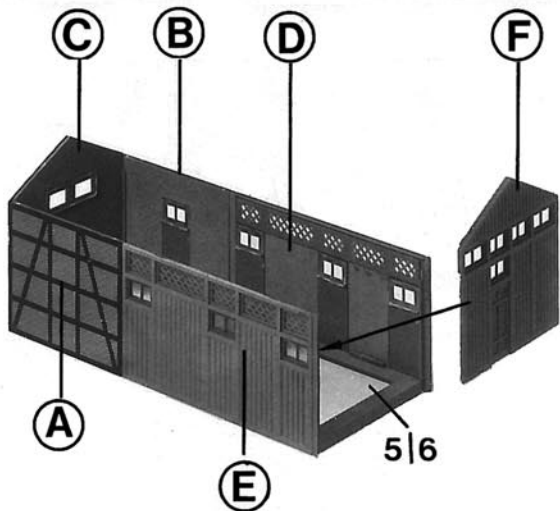

G

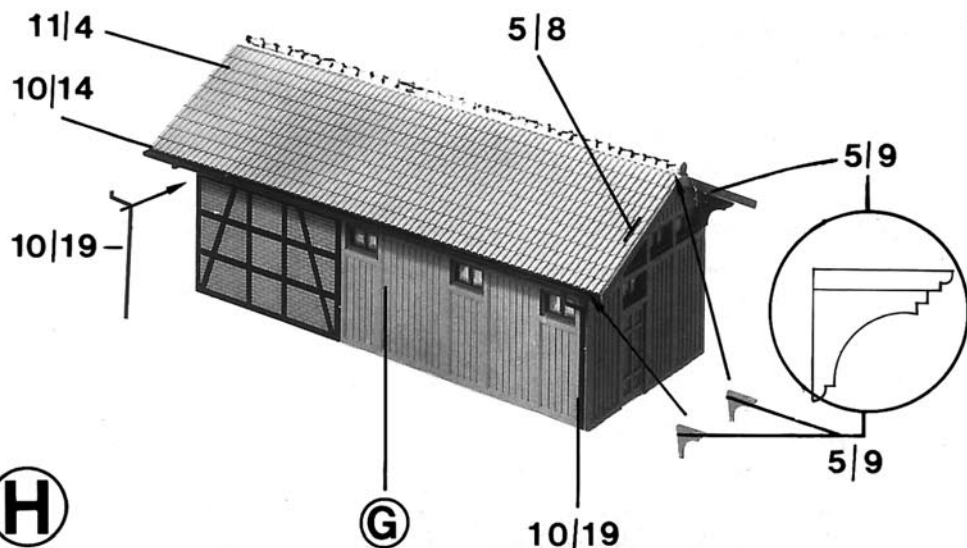

H

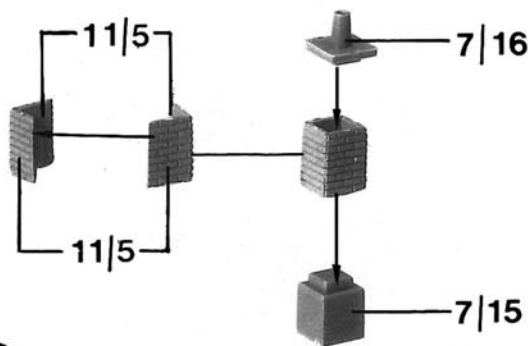

I

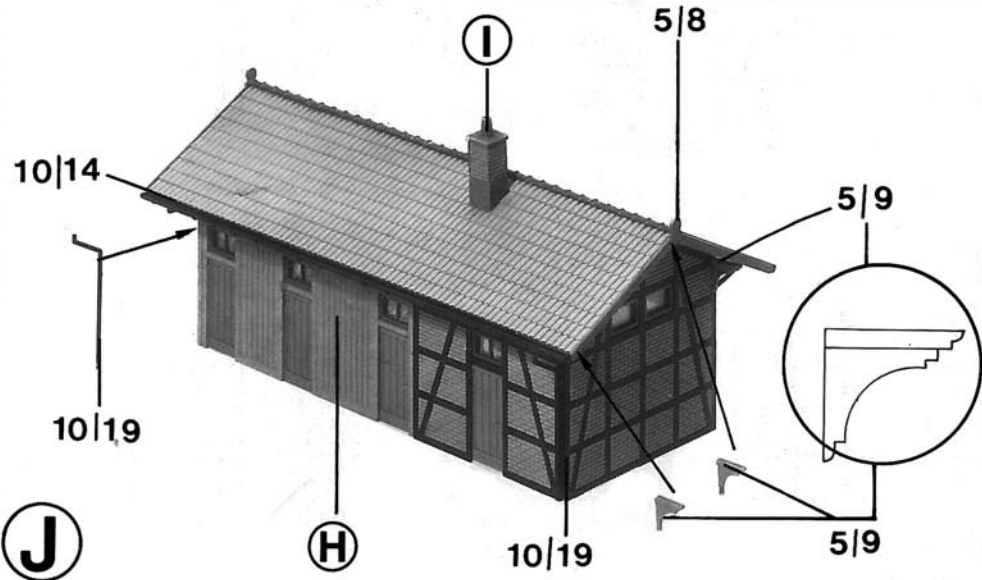

J

4

Spritzlinge	1	7	13
Sprues	2	8	14
Moulagés	6	9	
Gietstukken	6	9	

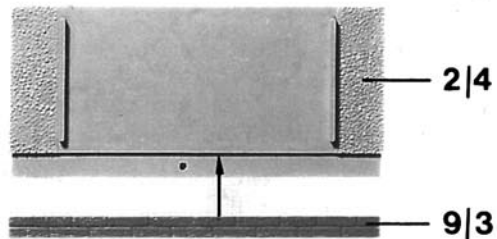

K

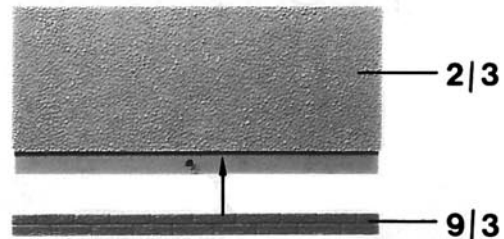

L

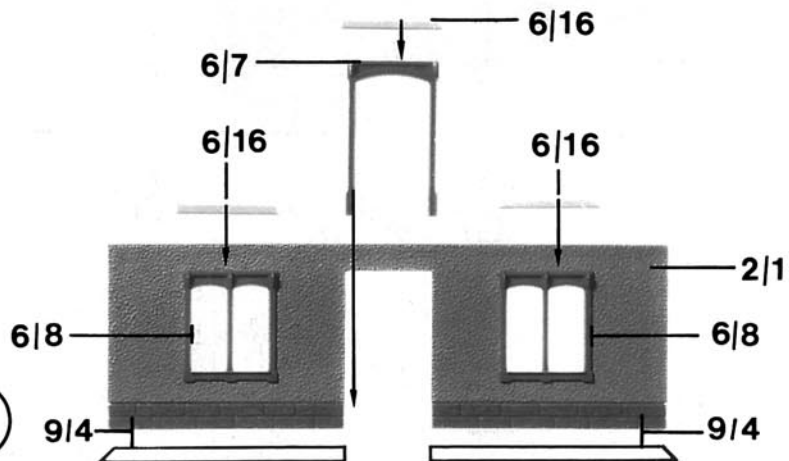

M

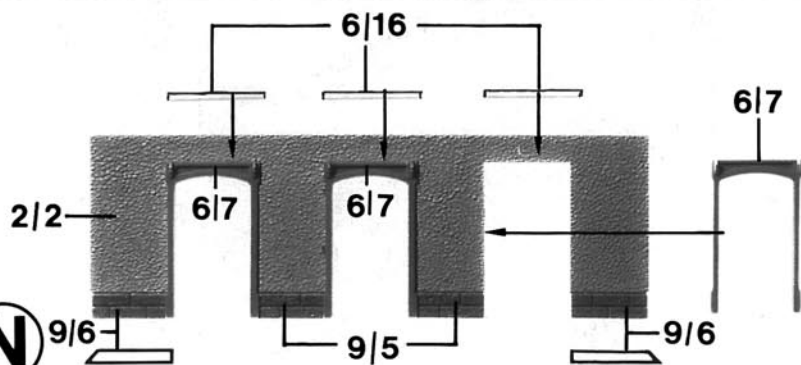
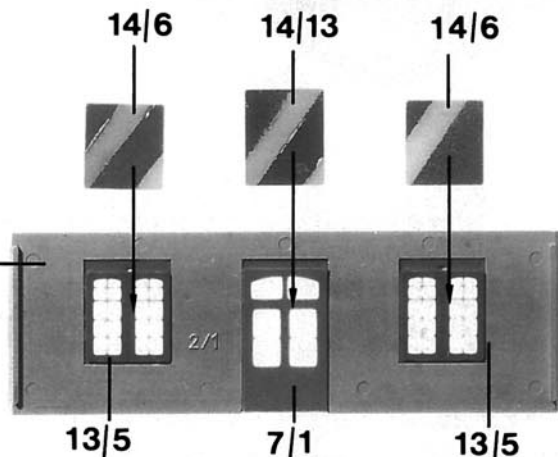

N

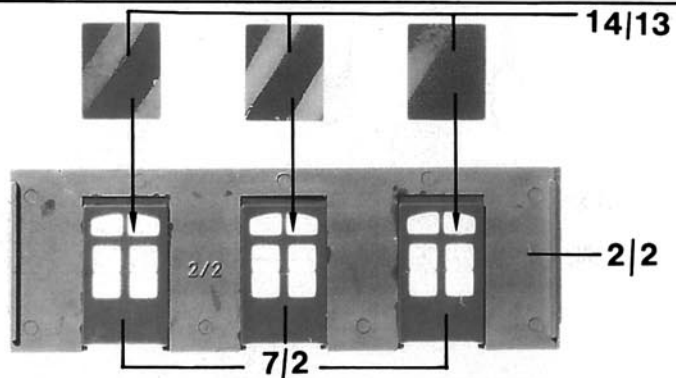

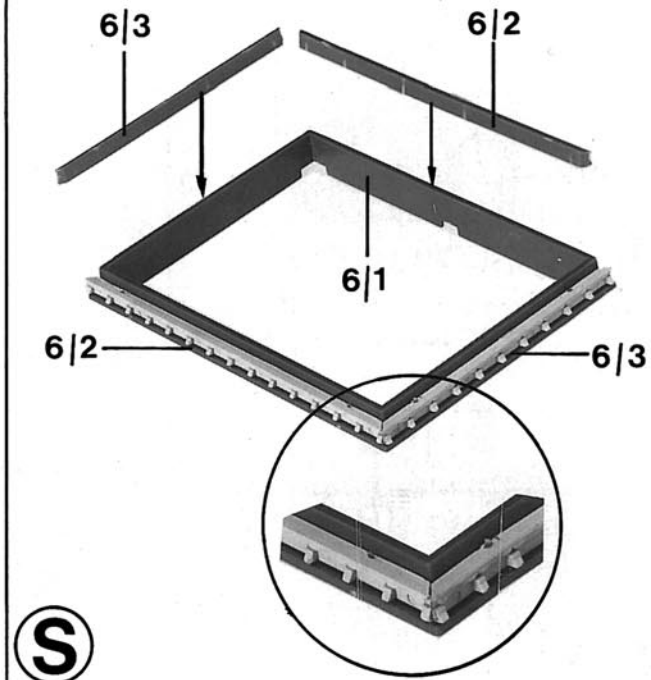
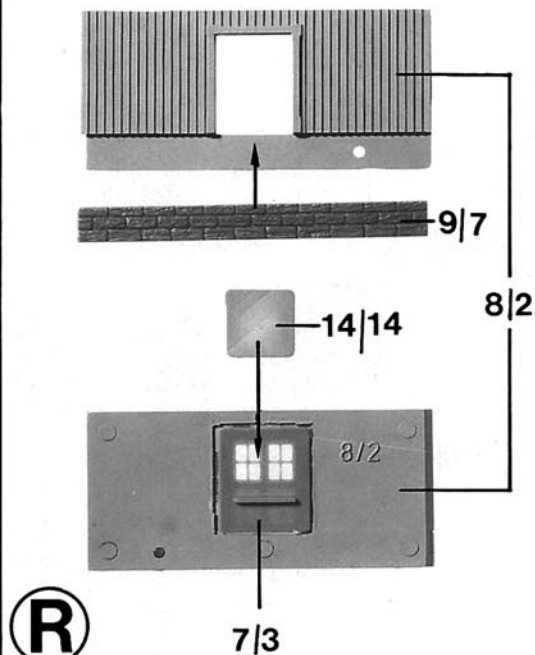
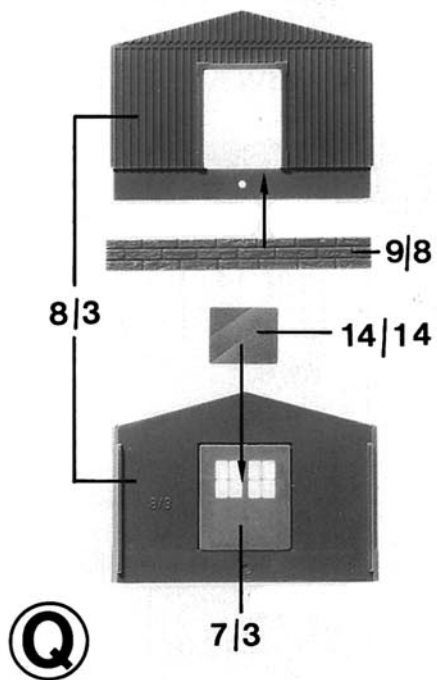
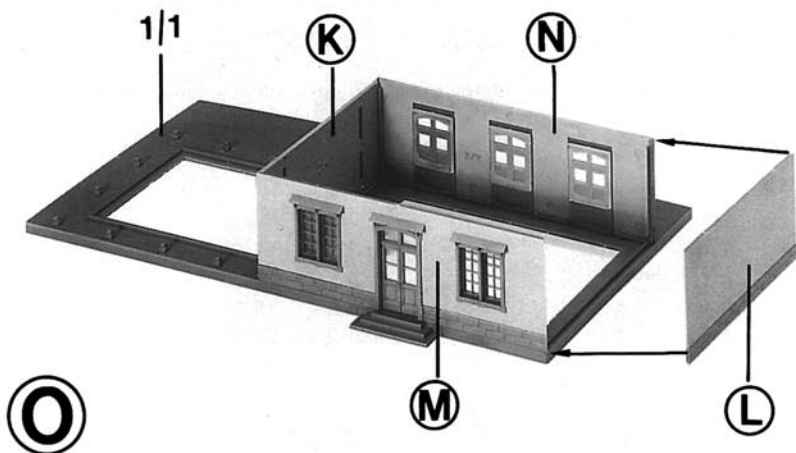

6

Spritzlinge	1	5	10
Sprues	3	6	13
Moules	4	7	14
Gietstukken	4	7	14

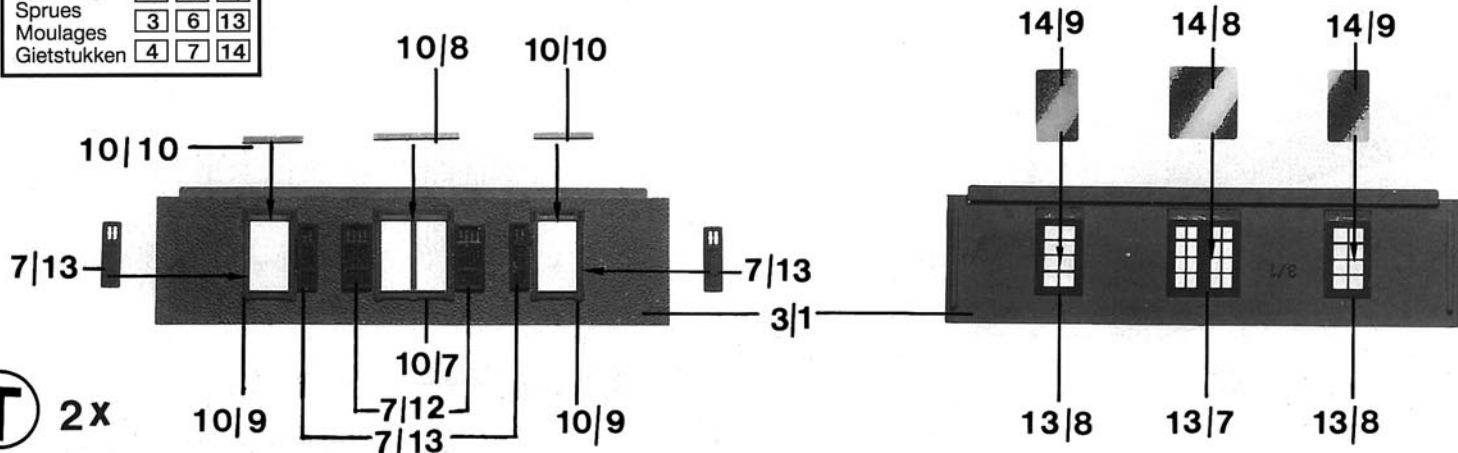

T 2x

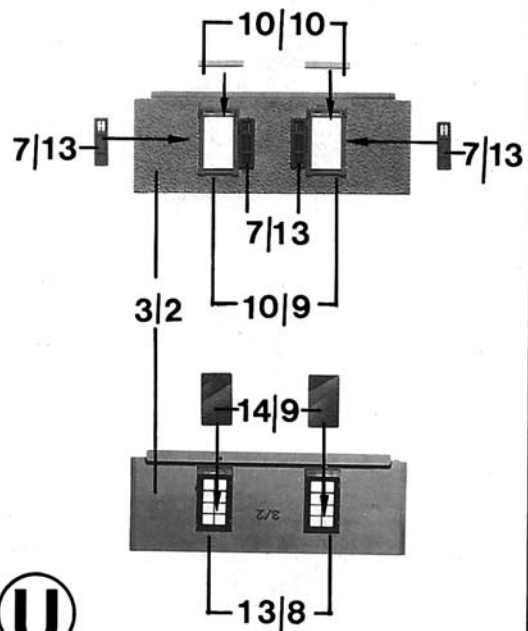

U

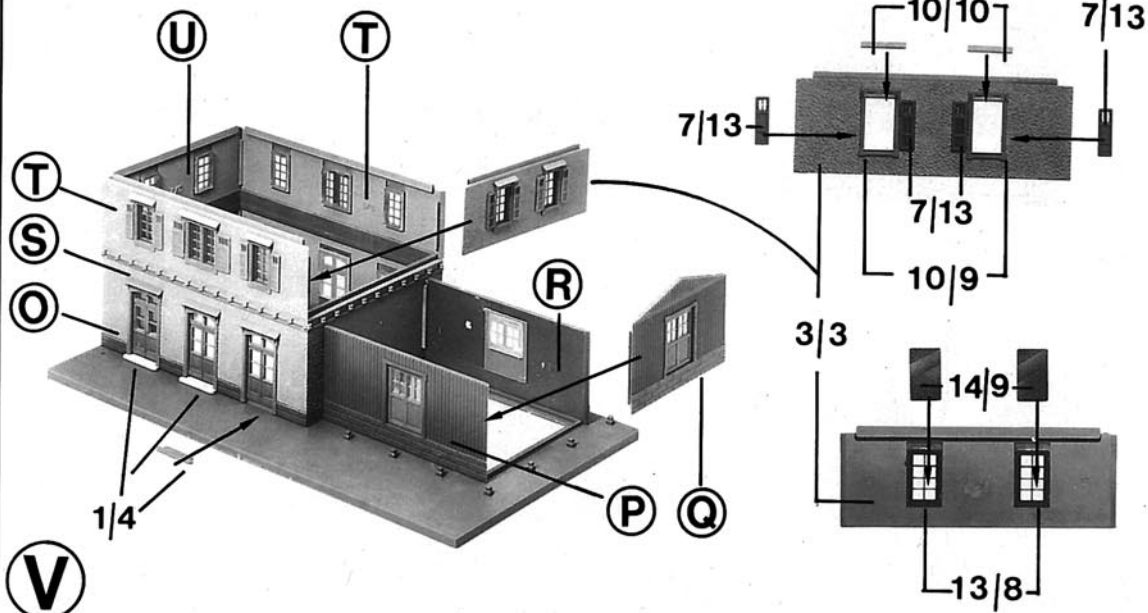

V

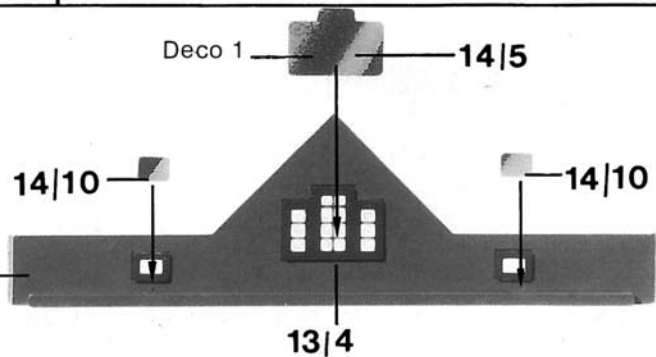
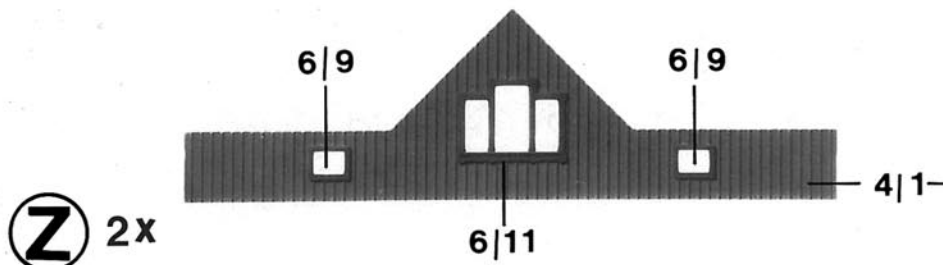
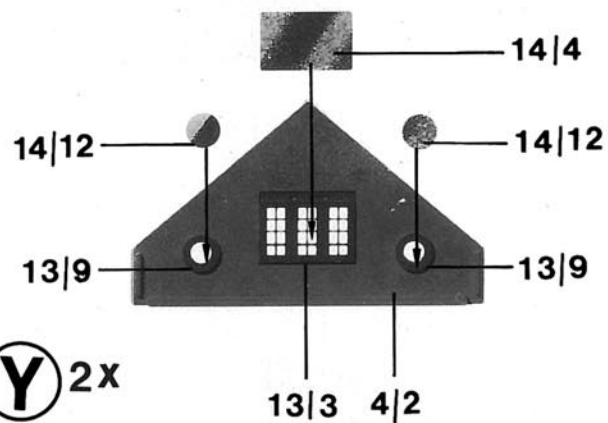
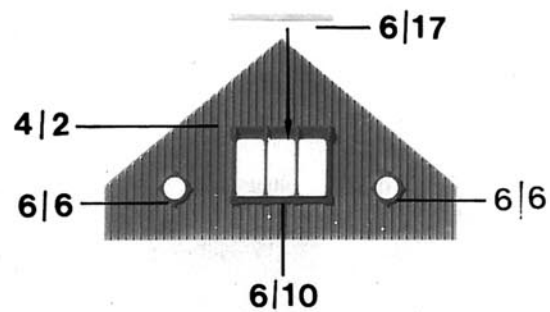
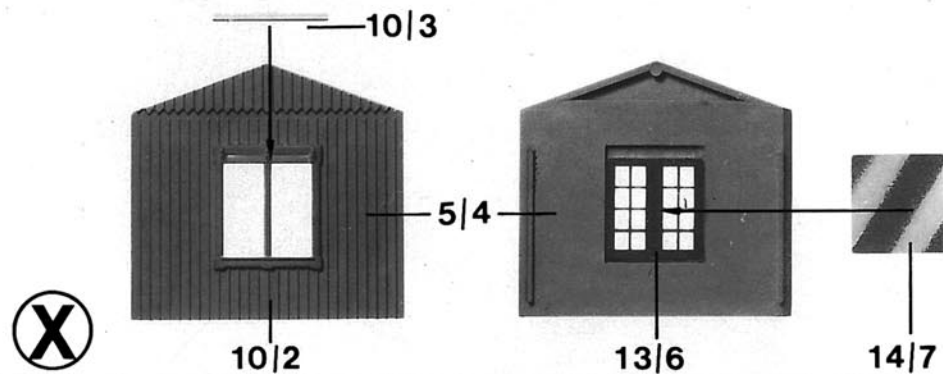
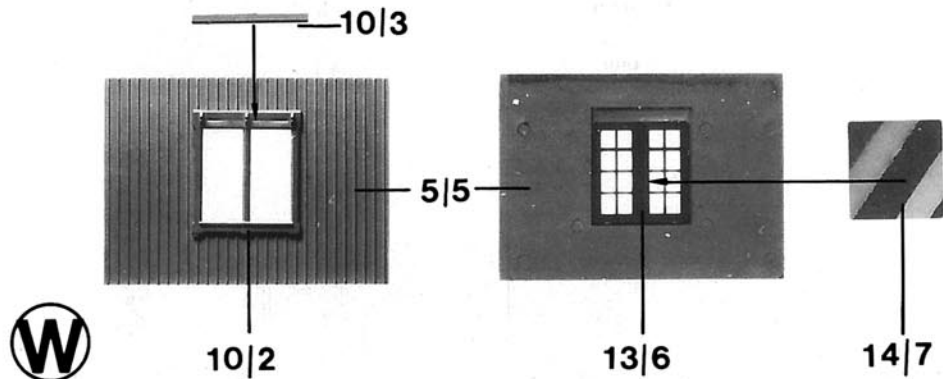

8

Spritzlinge	1	8	12
Sprues	6	9	14
Moulages	7	10	

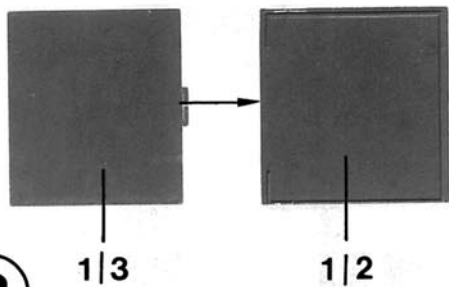
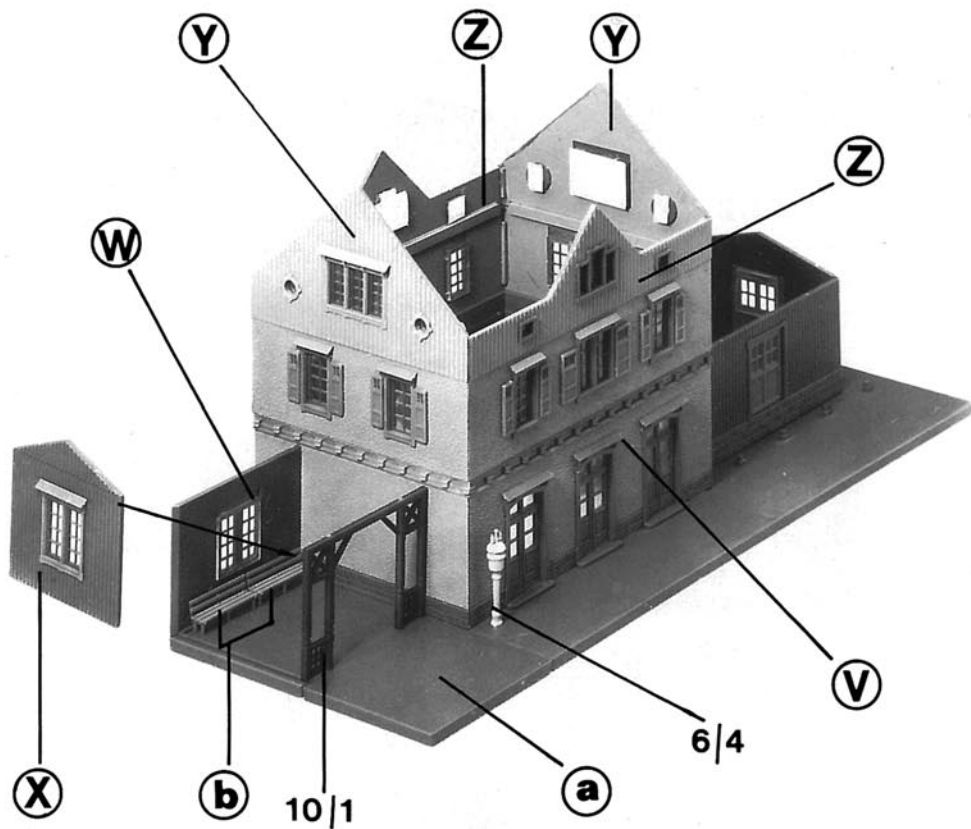
**a****b** 2x**c**

Papiermaske zur Lichtabdeckung
 Black - out masking paper
 Masque en papier noir
 Masker voor de lichtafscherming

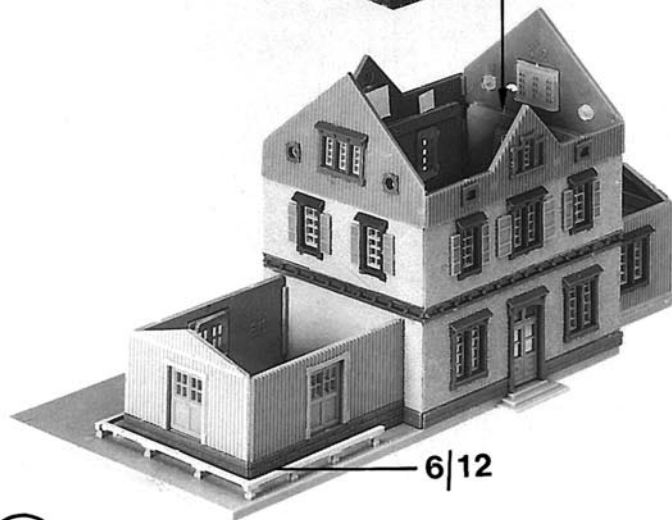
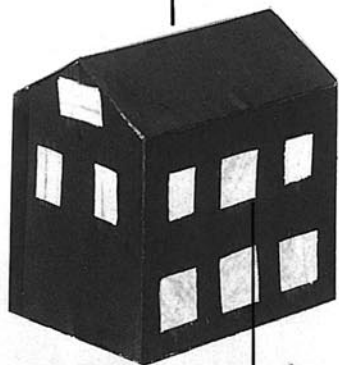

d

14|11

e

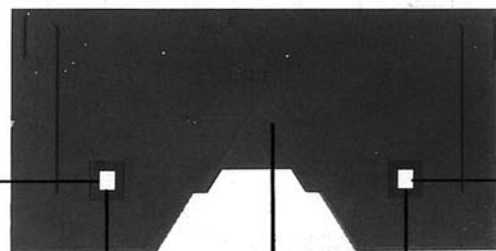

9|14

12|2

9|14

14|11

14|11

f

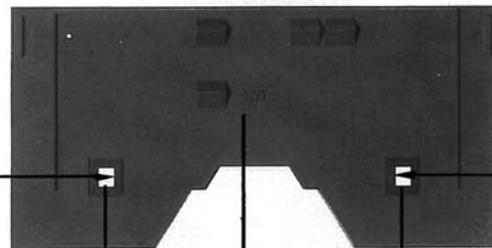

9|14

12|1

9|14

14|11

9|1

g

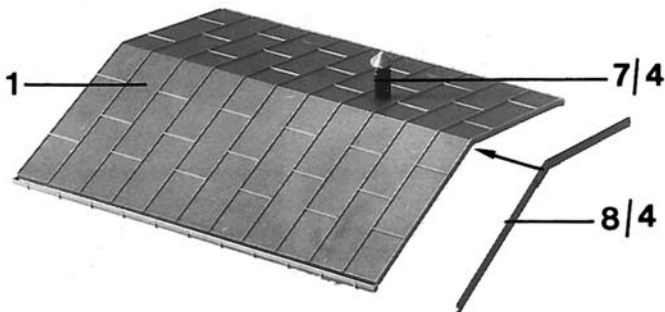

7|4

8|4

10

Spritzlinge	4	7	10
Sprues	5	8	12
Moulages	6	9	
Gietstukken	6	9	

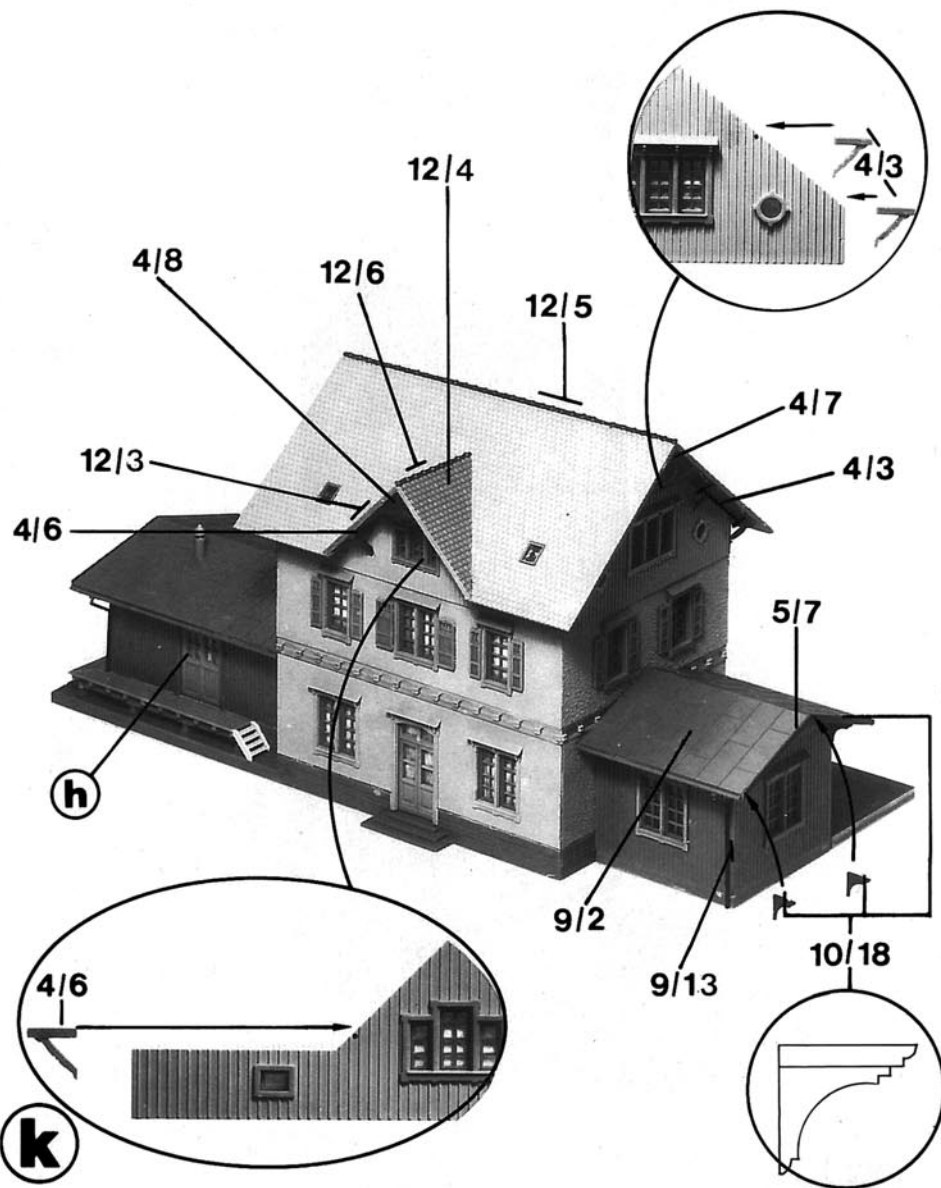
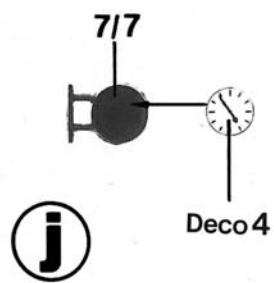
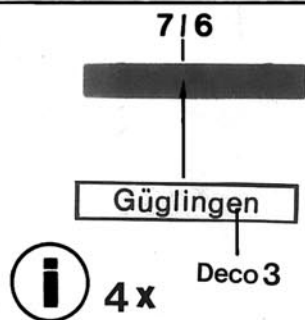
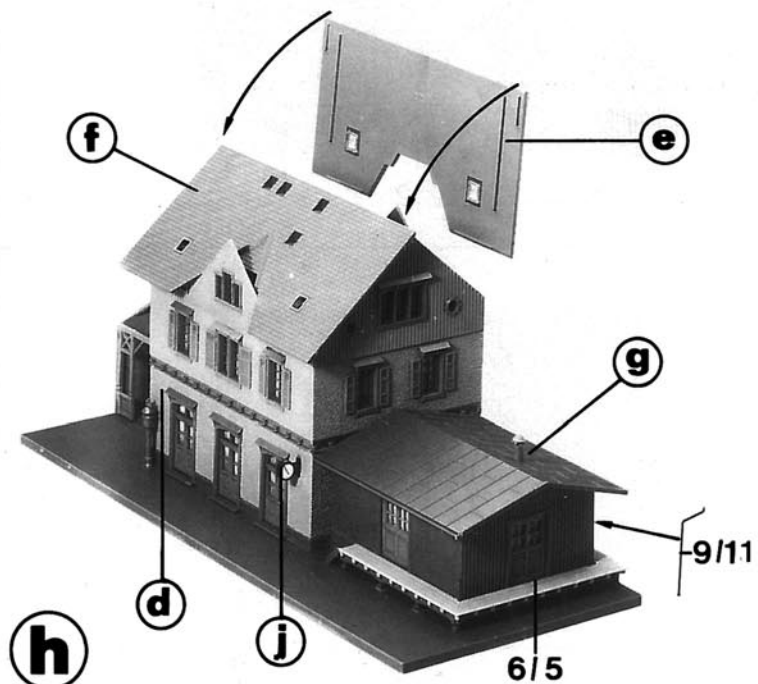

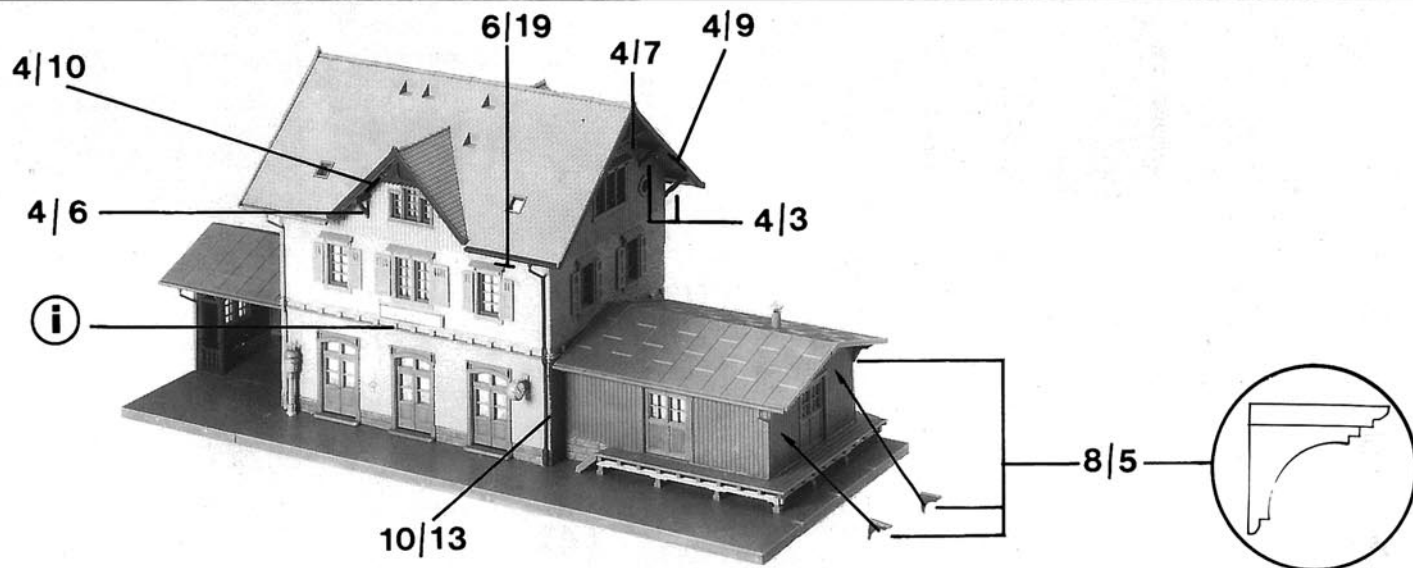
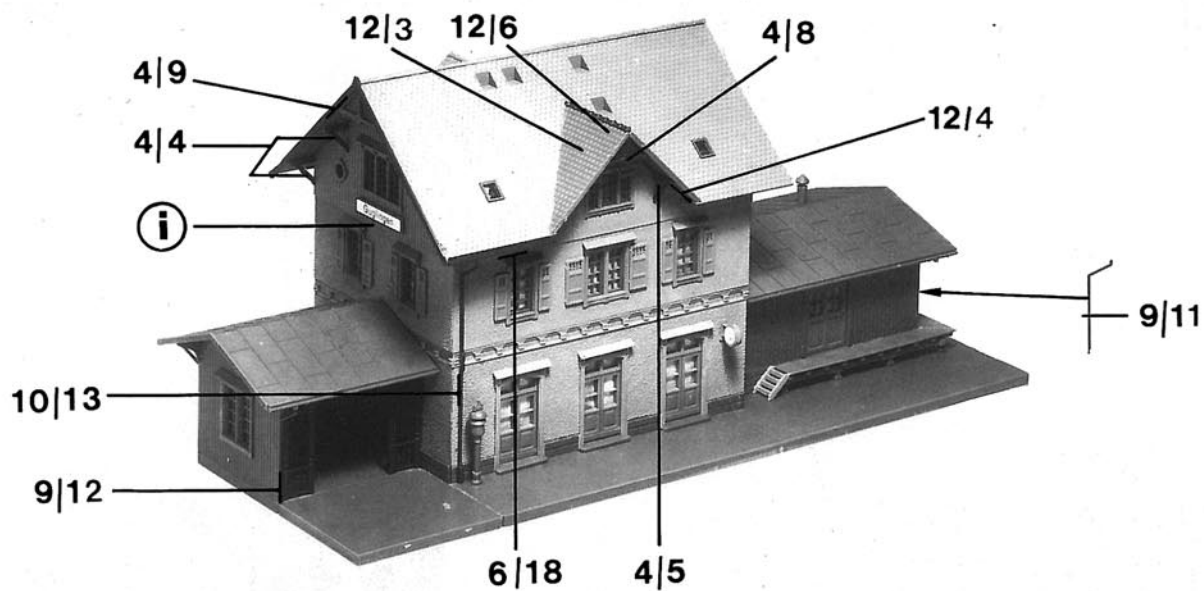

12

Spritzlinge	4	9
Sprues	6	10
Moulages		
Gietstukken	7	

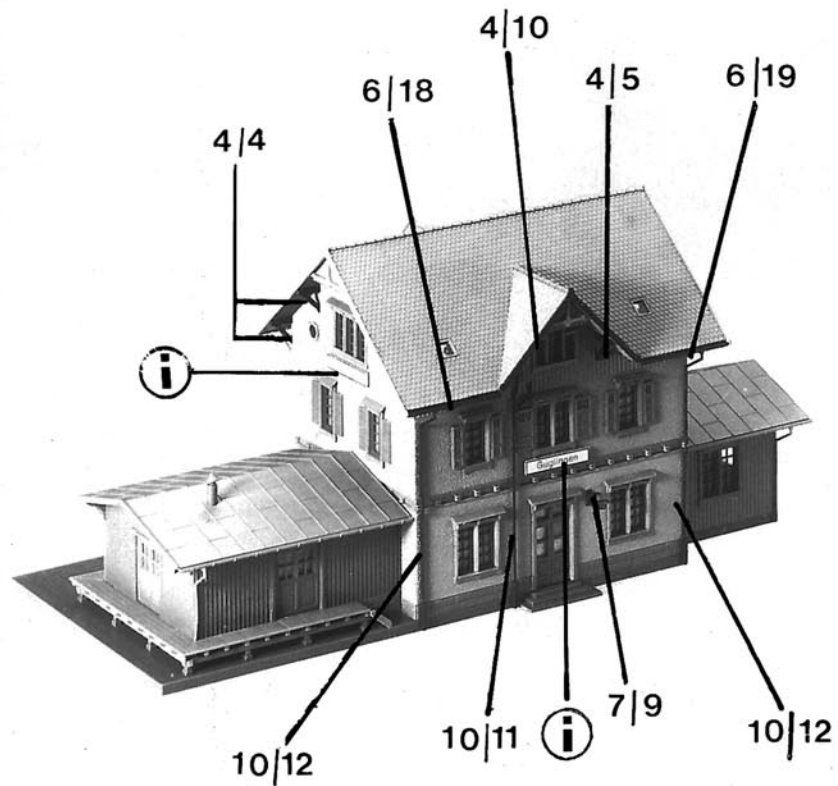

n

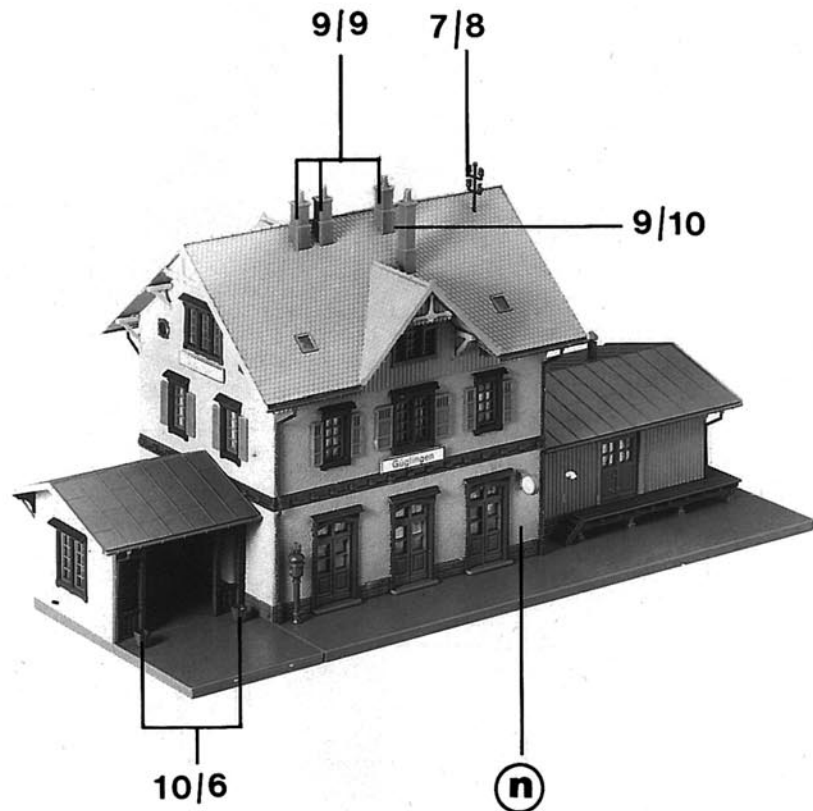

o