

BAHNHOF »OCHSENHAUSEN«



»OCHSENHAUSEN« STATION

GARE DE »OCHSENHAUSEN«

STATION »OCHSENHAUSEN«

Art. Nr. 282709

D

Machen Sie sich bitte vor Beginn des Bastelns mit dem Bausatzinhalt und der Anleitung vertraut und prüfen Sie die Vollständigkeit. Im Reklamationsfall gilt die gesetzliche Gewährleistungspflicht. Sollte ein Teil fehlen, übersenden Sie bitte den Teilwunsch und den Kaufbeleg an: Gebr. FALLER GmbH, Kundendienst, Kreuzstraße 9, D-78148 Gütenbach, kundendienst@faller.de. Sollten Sie einmal weitere Ersatzteile benötigen, senden wir Ihnen den benötigten Spritzling, bei Verfügbarkeit, gerne kostenpflichtig zu. Bitte beachten Sie, dass produktionsbedingt Einzelteile übrig bleiben können.

GB

Before building your model, please familiarize yourself with the contents of the kit and the instructions for use, also checking whether the set of parts is complete. In case of any complaint, the legal guarantee obligation shall apply. Should a part be missing, please send the designation of the part required and the receipt documenting your purchase to: Gebr. FALLER GmbH, Kundendienst, Kreuzstraße 9, D-78148 Gütenbach, kundendienst@faller.de. Should you require further spare parts one day, we shall be pleased to send you, with costs, the required sprue, if it is available. Please note that, on grounds of the production process, some single injection molded parts may be superfluous.

F

Avant de commencer votre modèle, veuillez vous familiariser avec le contenu du kit et la notice d'emploi, et contrôlez que le lot de pièces est complet. En cas de réclamation, il s'appliquera l'obligation de garantie légale. Au cas où une pièce manquerait, veuillez envoyer la désignation de la pièce souhaitée et le bon d'achat à: Gebr. FALLER GmbH, Kundendienst, Kreuzstraße 9, D-78148 Gütenbach, kundendienst@faller.de. Au cas où vous auriez besoin un jour d'autres pièces détachées, nous vous enverrons volontiers la grappe requise, si elle est disponible, contre paiement. Veuillez noter que, pour des raisons de production, il se peut que des pièces détachées soient superflues.

NL

Maak uzelf vóór het bouwen vertrouwd met de inhoud van het bouwpakket en met de handleiding en controleer de volledigheid. In geval van reclamatie geldt de wettelijke garantieverplichting. Macht er een onderdeel ontbreken, stuur het verzoek om de gewenste onderdeel en het aankoopbewijs dan naar: Gebr. FALLER GmbH, klantenservice, Kreuzstraße 9, D-78148 Gütenbach, kundendienst@faller.de. Als u ooit meer reserveonderdelen nodig hebt, sturen wij het benodigde gietstuk, indien beschikbaar, graag tegen betaling naar u op. Let op: om productieredenen kunnen losse onderdelen overblijven.

Für den Zusammenbau des Modells empfehlen wir folgende FALLER-Artikel (sind nicht im Bausatz enthalten):

For the assembly of the kit we recommend following FALLER products (not included in the kit):

Pour l'assemblage du modèle, nous vous recommandons les articles FALLER suivants (non inclus dans le kit):

Om dit model te bouwen adviseren wij de volgende FALLER producten (maken geen deel uit van deze bouwset):

Art. Nr. 170492
FALLER-EXPERT

Flüssigkleber in Plastikflasche mit Spezialkanüle für feinste Klebstoffdosierung.

Liquid cement in plastic bottle with canule for very fine dosage.

Cette liquide en bouteille plastique avec bec verseur pour un dosage précis.

Vloeibare lijm in plastic-flescon met doseerbuisje om nauwkeurig te lijmen.



Art. Nr. 170688
SPEZIAL-SEITENSCHNEIDER

zum geratlosen Abtrennen von feinsten Spritzteilen.
Nur für Polystyrol geeignet.

Special side cutter for cutting off ultra-fine moulded parts without burrs.
Only suitable for polystyrene.

Pince coupants spéciale pour couper sans bavure les pièces miniatures moulées par injection. Convient uniquement au polystyrène.

Speciale zijknijptang voor het braamloos afknippen van de fijnste gietstukdelen. Alleen geschikt voor polystyrol.



Inhalt	Spritzlinge	1	1	x	3	1	x	5A	1	x	7	1	x
Contents	Sprues	1	1	x	3	1	x	5B	1	x			
Contenu	Moulages												
Inhoud	Gietstukken	2	1	x	4	1	x	6	1	x			

Sa. Nr. 282 709 1

2

Fensterfolie

Das abgebildete Papier-Musterfenster mit transparentem Kleband auf die beiliegende Fensterfolie kleben und diese ausschneiden. Fensterfolie vorsichtig mit wenig Klebstoff auf die Rückseite der Fensterrahmen aufkleben.

Window plastic sheet

Using clear adhesive tape fix the pattern window made of paper pictured to the window plastic sheet supplied, and cut that sheet out. Using very little glue, cautiously stick the window sheet to the back of the window frame.

Feuille transparente pour fenêtres

À l'aide de ruban adhésif transparent coller la fenêtre à dessin en papier représentée sur la feuille transparente fournie, et découper cette feuille. Coller avec précaution la feuille transparente, avec très peu de colle, au dos du cadre de la fenêtre.

Raamfolie

De afgebeelde papieren raamdecoratie met transparant plakband op de meegeleverde raamfolie plakken en uitknippen. Raamfolie voorzichtig met een beetje lijm op de achterzijde van de ramen lijmen.

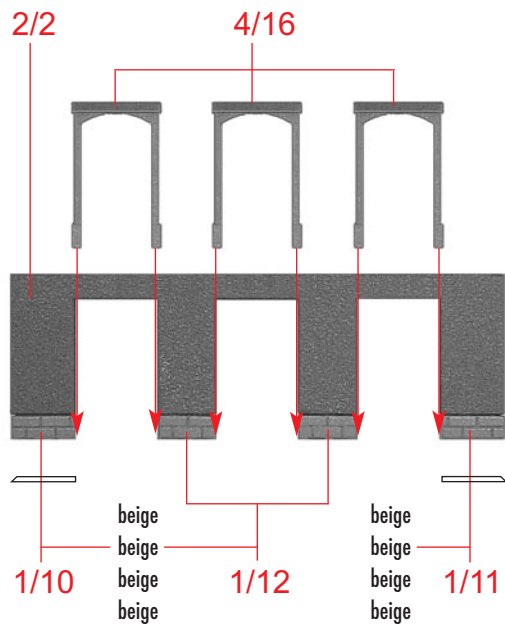
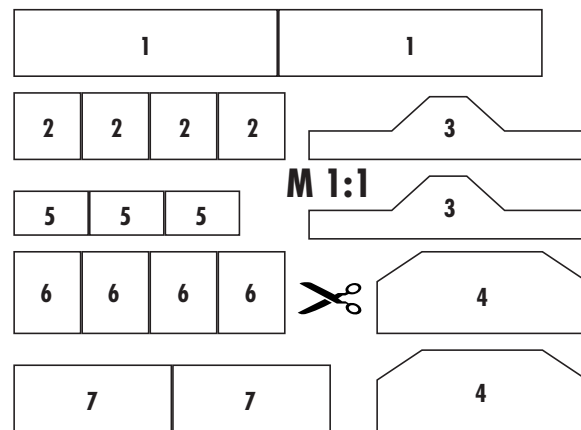

A

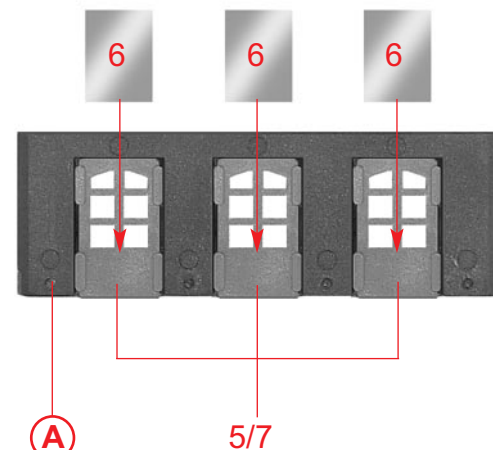

B

A

(C) 2 x

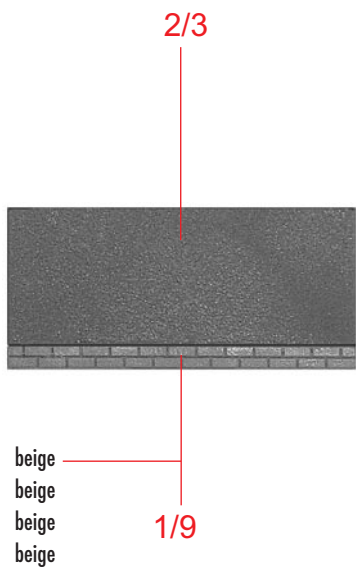

(D)

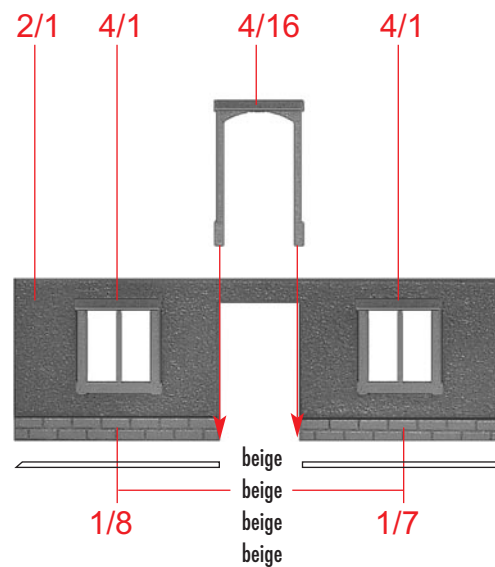

(E)

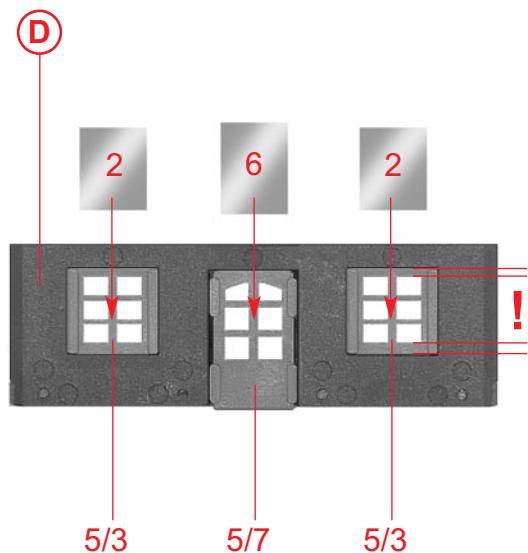

(F)

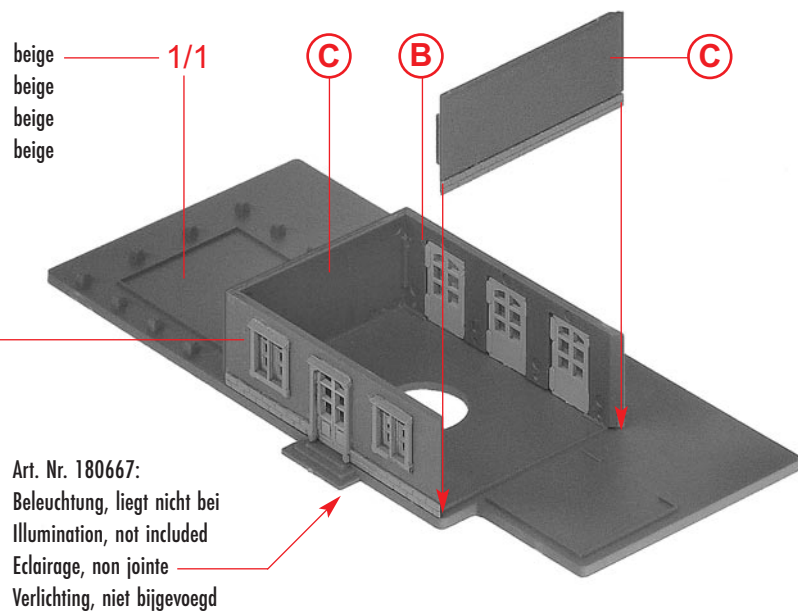

4

Papiermaske
Papermask
Masque
Masker **M1**



F

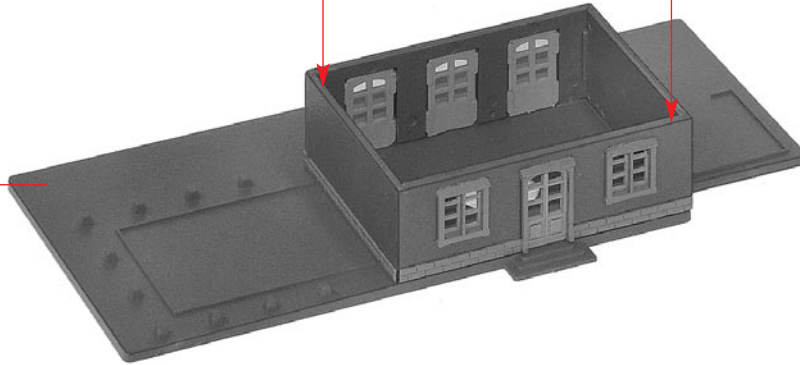

G

2/4

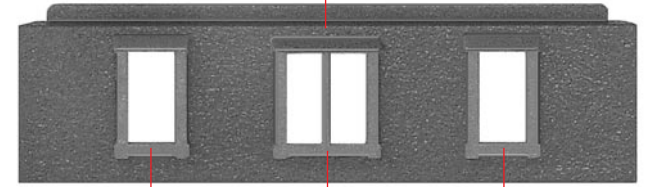

I 2 x

4/2

4/1

4/2

4/9

4/10

4/18

4/10

!

4/9

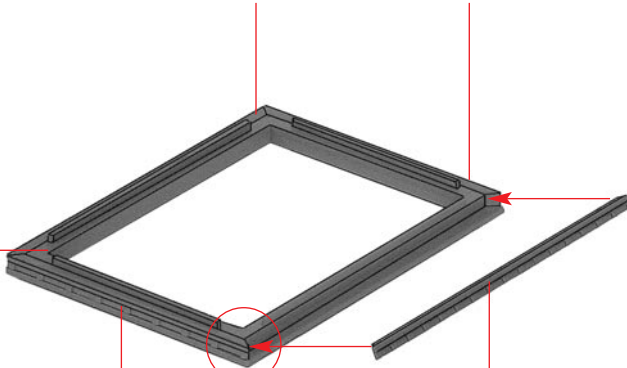

H

5/1

5/3

5/1

I

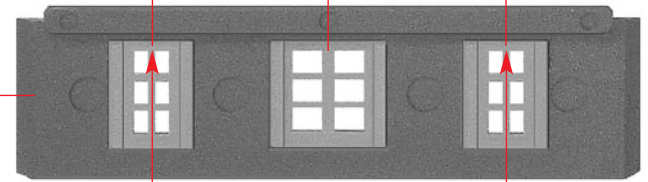

J 2 x

1

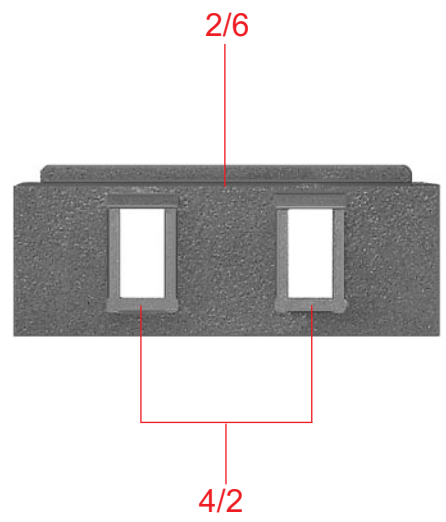

K 2 x

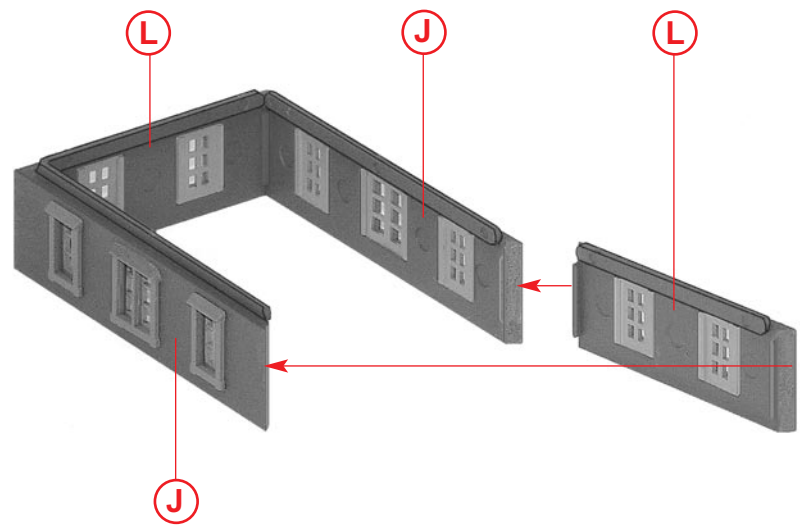

M **J** **L**

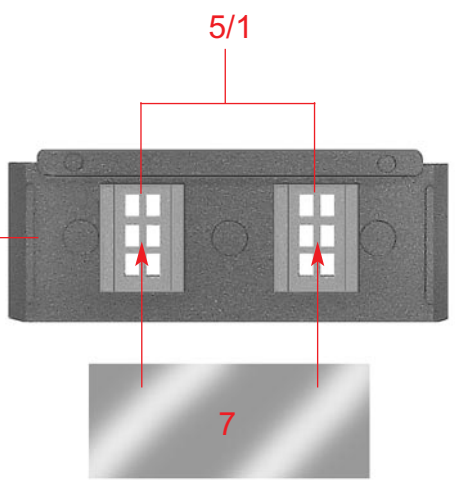

L 2 x

Papiermaske
Papermask
Masque
Masker **M2**

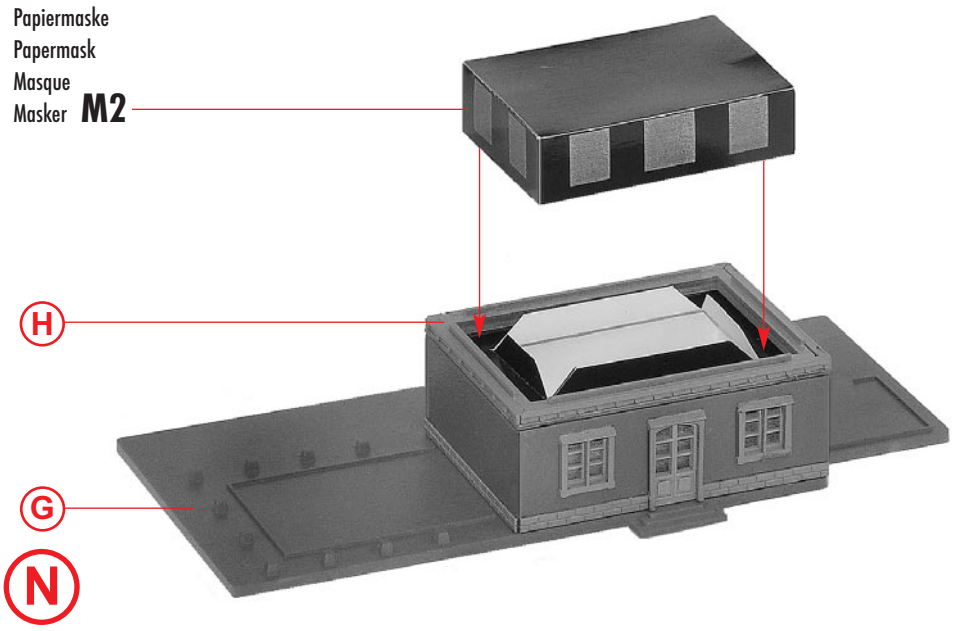

H

G

N

6

M

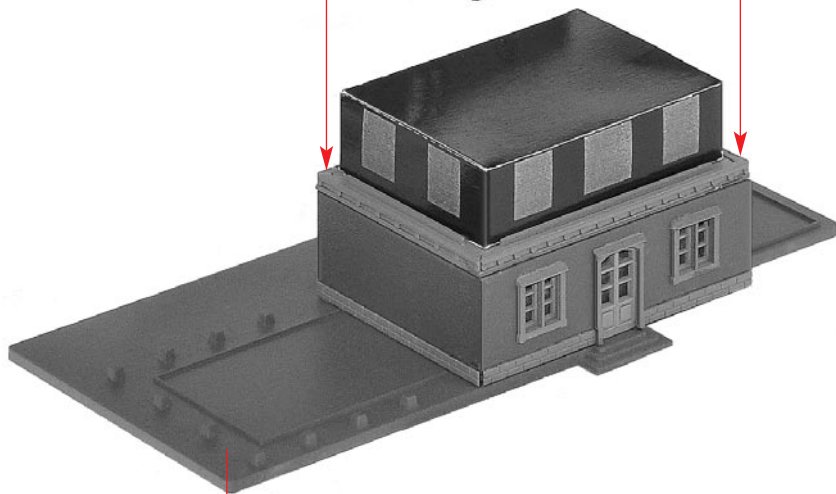
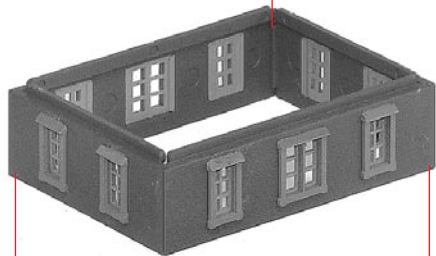

O

N

3/6 — beige
beige
beige
beige

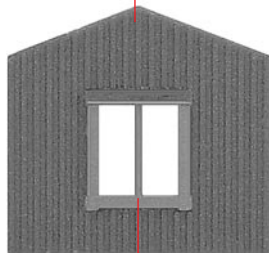

P

4/1

P 5/3

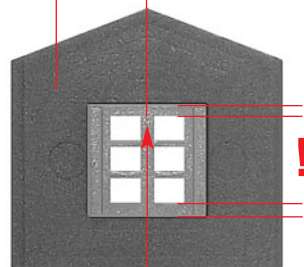

Q

2

3/7 — beige
beige
beige
beige

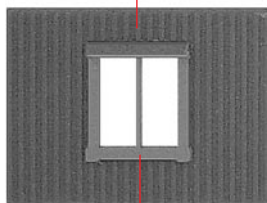

R

4/1

R 5/3

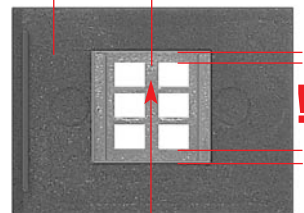

S

2

4/19

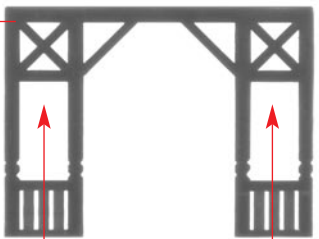

Lasercut-Kleber verwenden.
 Use Lasercut glue.
 Utilisez la colle Lasercut.
 Gebruik Lasercutlijm.

7/1

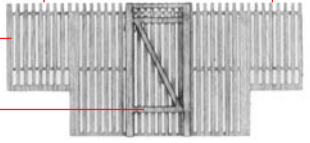

7/2

T



T

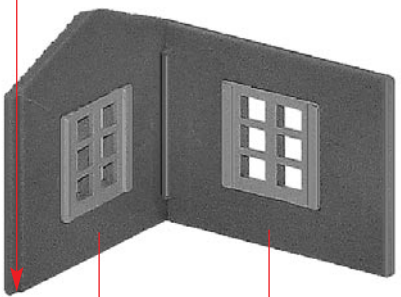
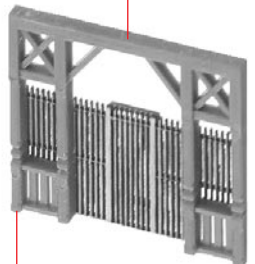

U

Q

S

4/7

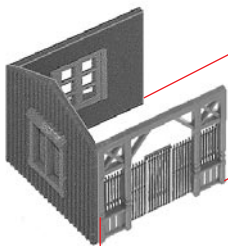

V

U

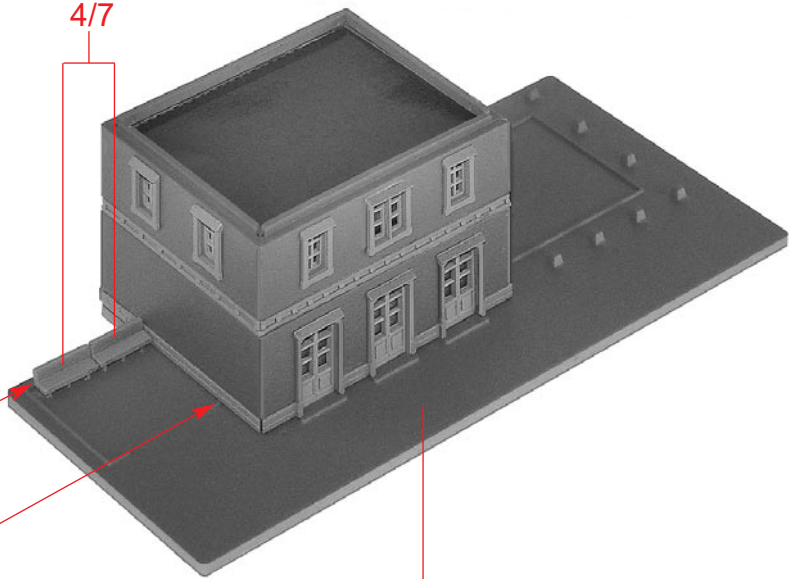

O

8

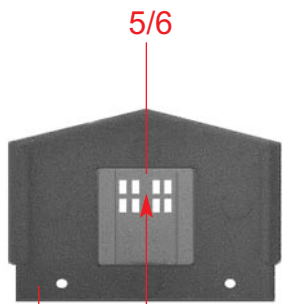

5

beige
beige
beige
beige

3/5

(a)

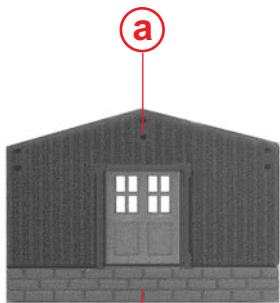

a

beige
beige
beige
beige

1/6

(b)

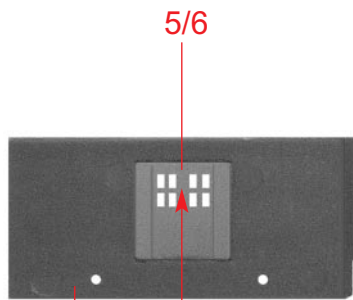

5/6

5

beige
beige
beige
beige

3/4

(c)

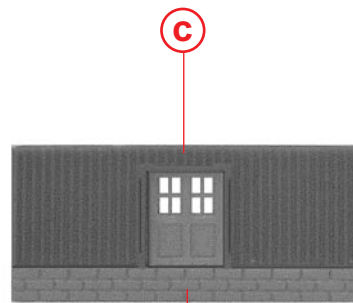

c

beige
beige
beige
beige

1/5

(d)

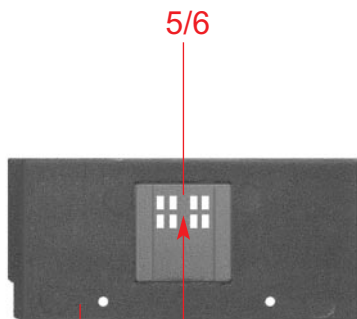

5/6

5

beige
beige
beige
beige

3/3

(e)

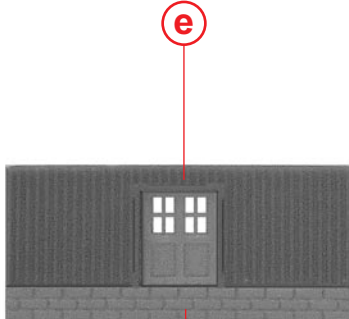

e

beige
beige
beige
beige

1/4

(f)

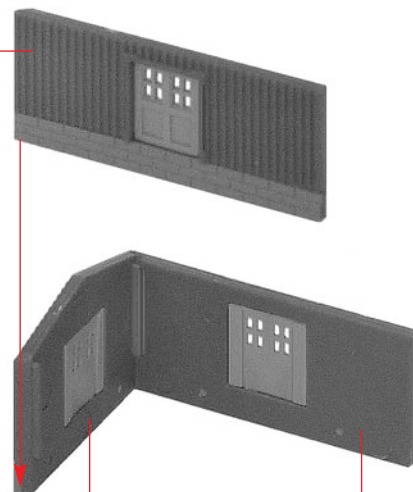

d

b

(g)

f

v

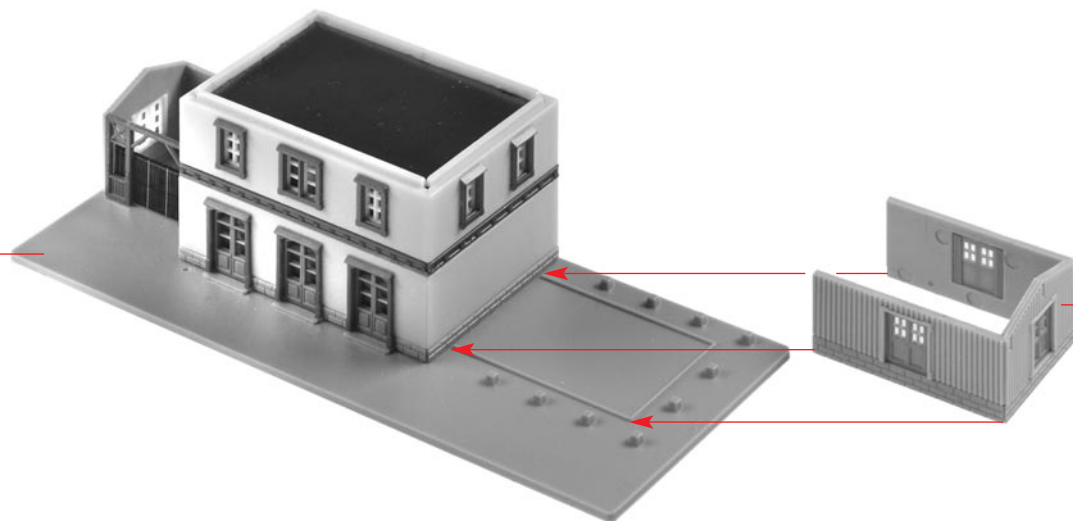

g

h

1/2

dunkelgrau
dark-grey
gris foncé
donkergrijs



dunkelgrau
dark-grey
gris foncé
donkergrijs

1/3

beige
beige
beige
beige

3/15

3/17

3/16

4/17

h

i

10

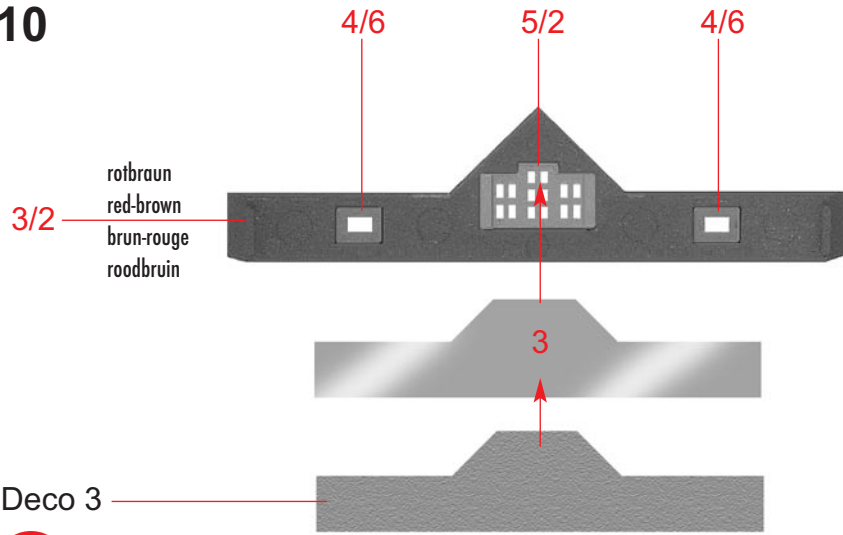

j 2 x

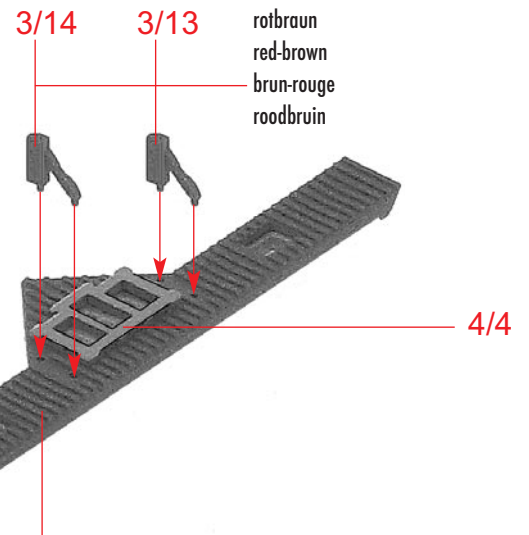

k 2 x

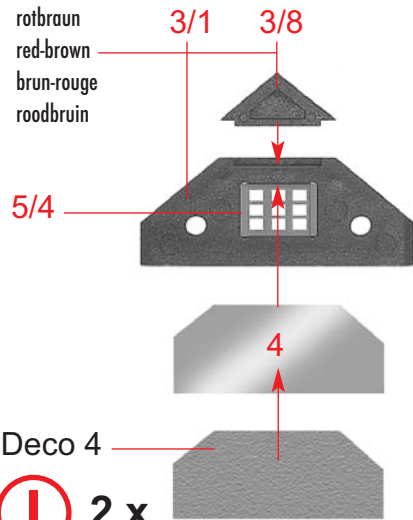

l 2 x

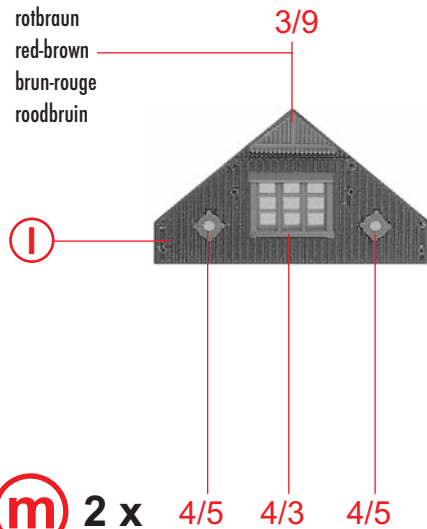

m 2 x

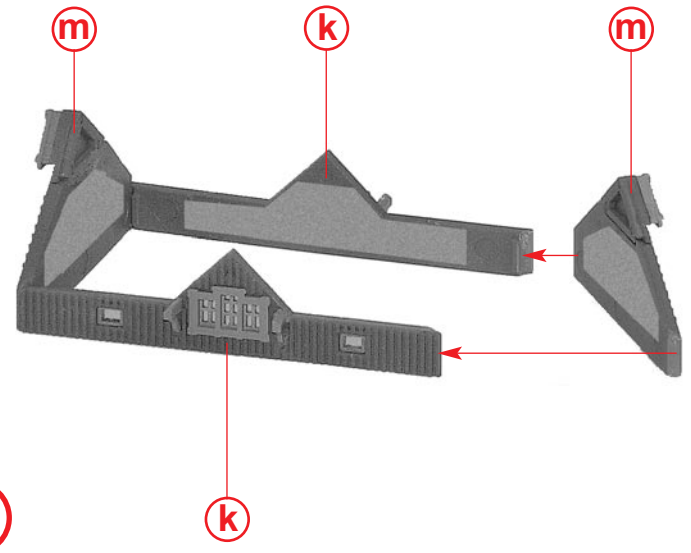

n

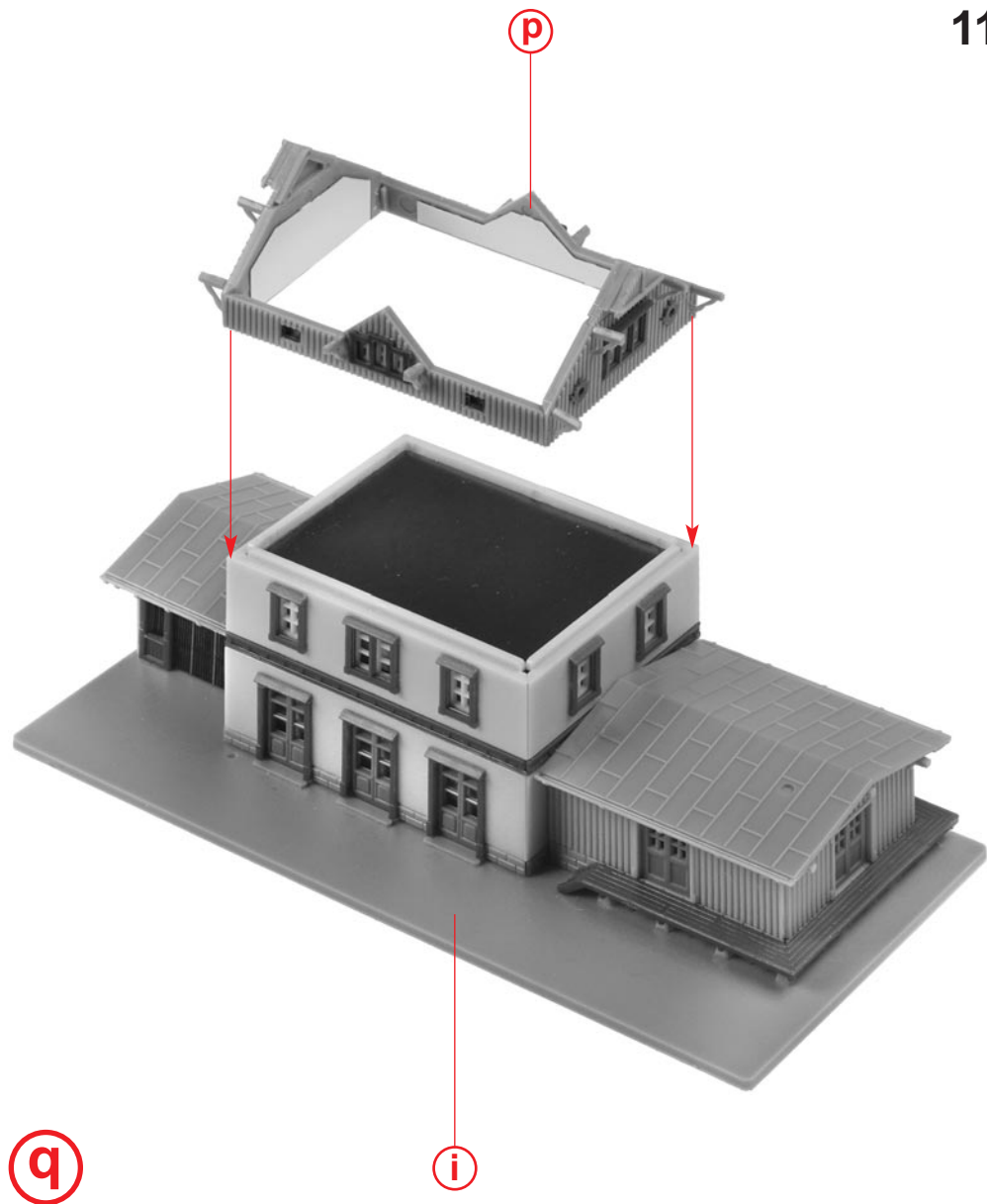
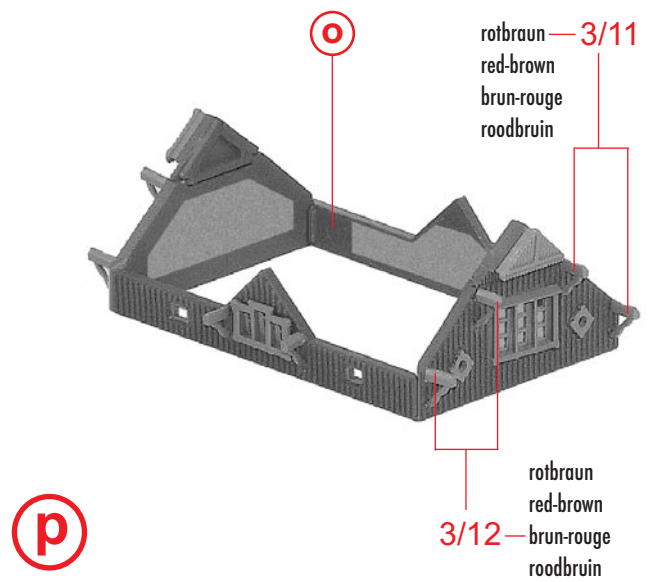
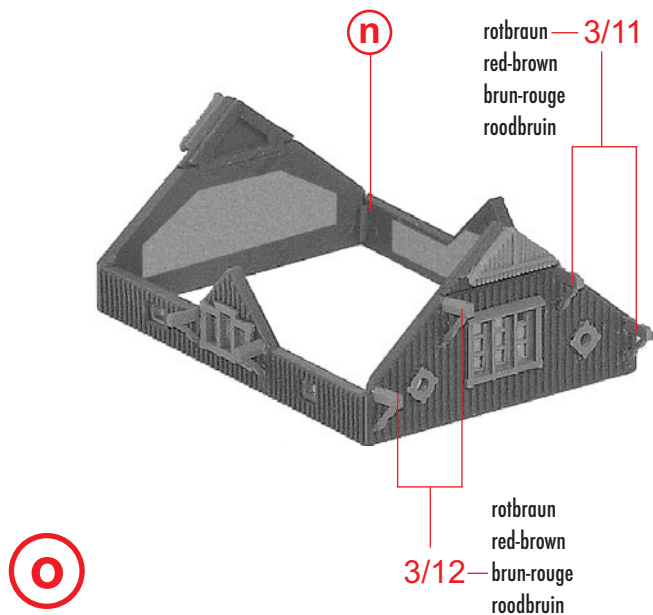

12



Fensterfolie
Window foil
Feuillet transparent
Vensterfolie

Deco 2

Deco 2

6/1

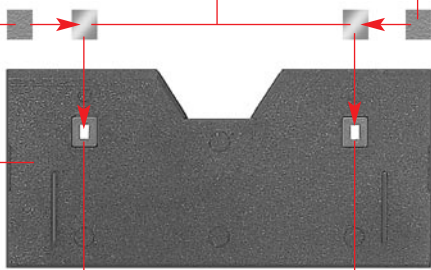

4/25

r



Fensterfolie
Window foil
Feuillet transparent
Vensterfolie

Deco 2

Deco 2

6/2

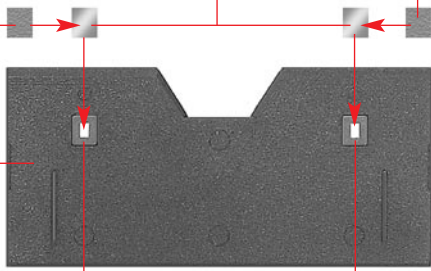

4/25

s

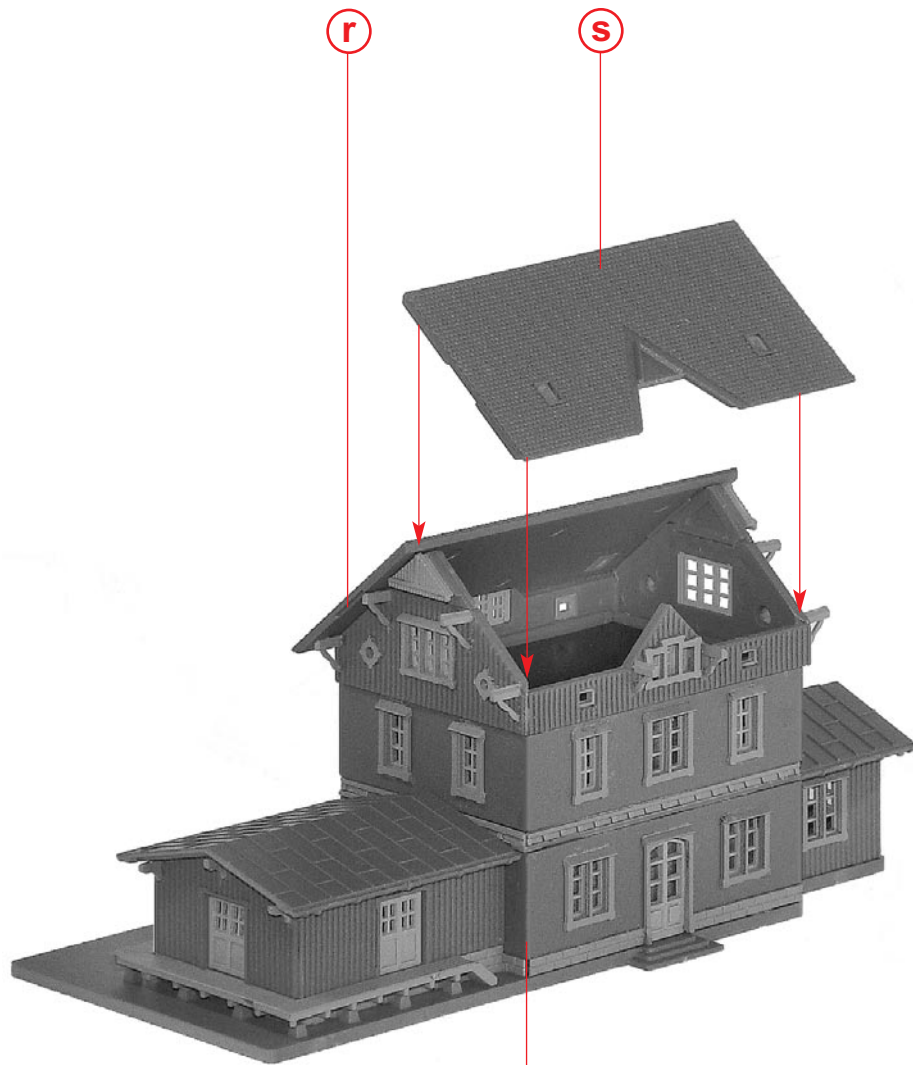

t

q

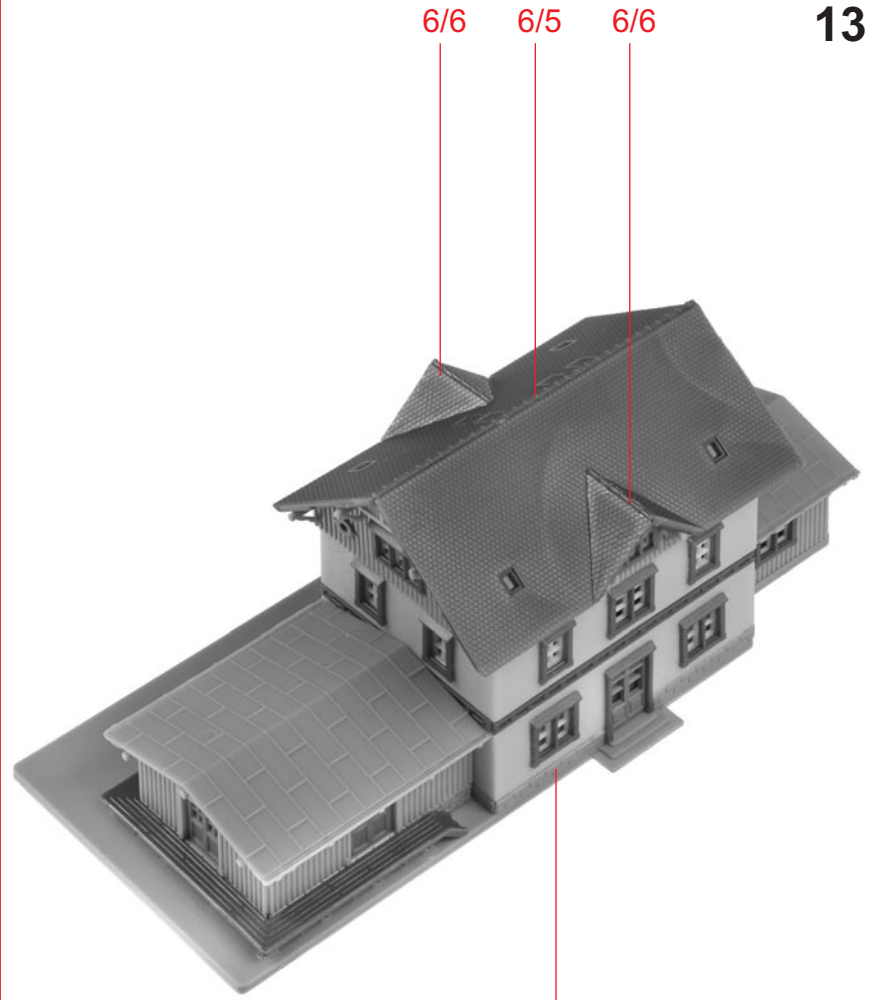
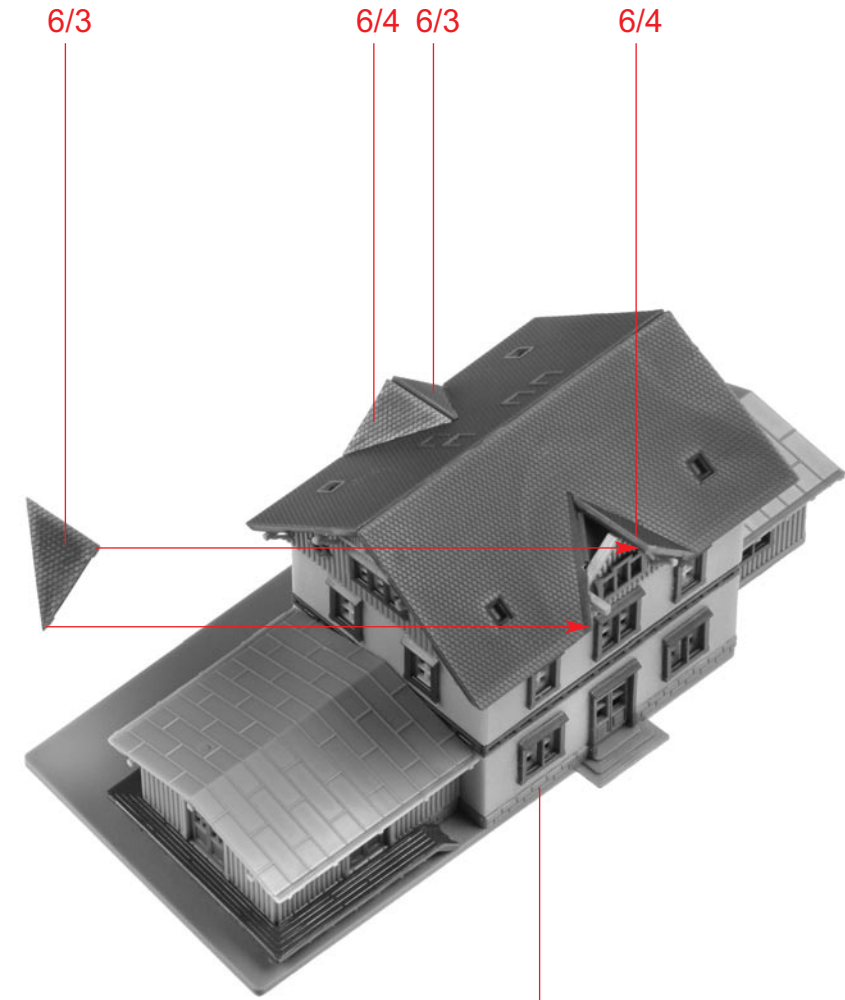

14

3/18

rotbraun
red-brown
brun-rouge
roodbruin

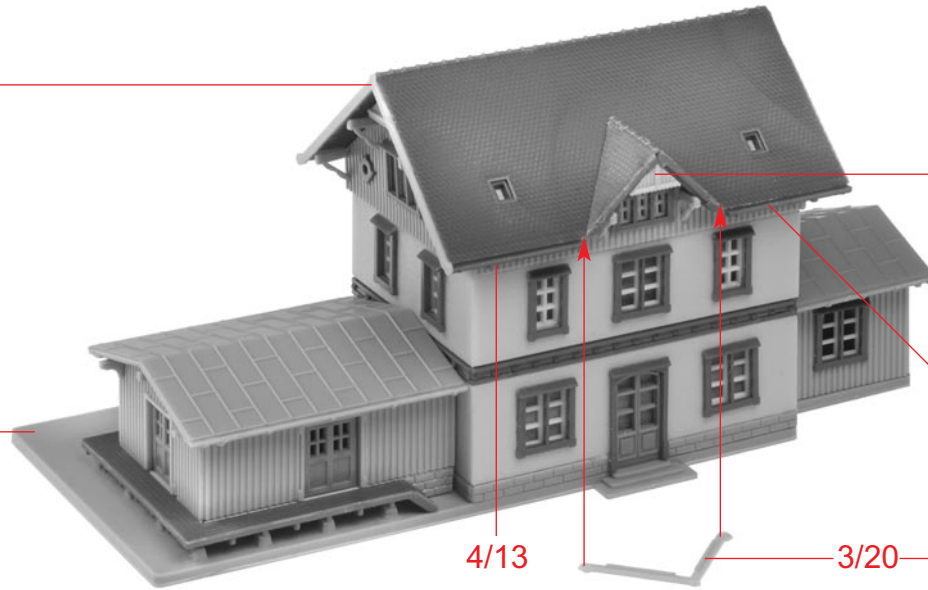

rotbraun
red-brown
brun-rouge
roodbruin

3/10

V

W

4/13

3/20

rotbraun
red-brown
brun-rouge
roodbruin

4/12

3/18

rotbraun
red-brown
brun-rouge
roodbruin

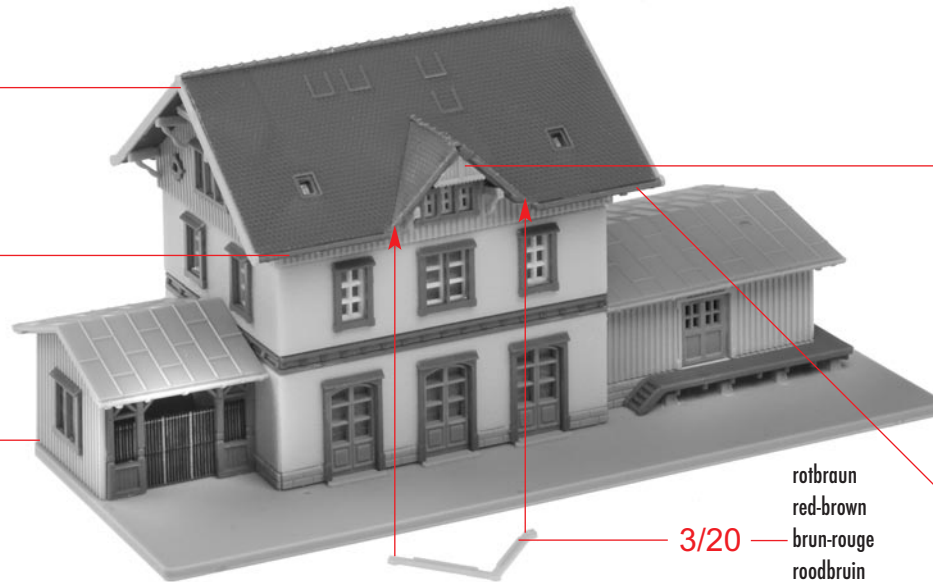

rotbraun
red-brown
brun-rouge
roodbruin

3/10

4/13

W

X

3/20

rotbraun
red-brown
brun-rouge
roodbruin

4/12

4/15

4/14

Deco 1

4/22

4/22

4/23

4/27

y

x

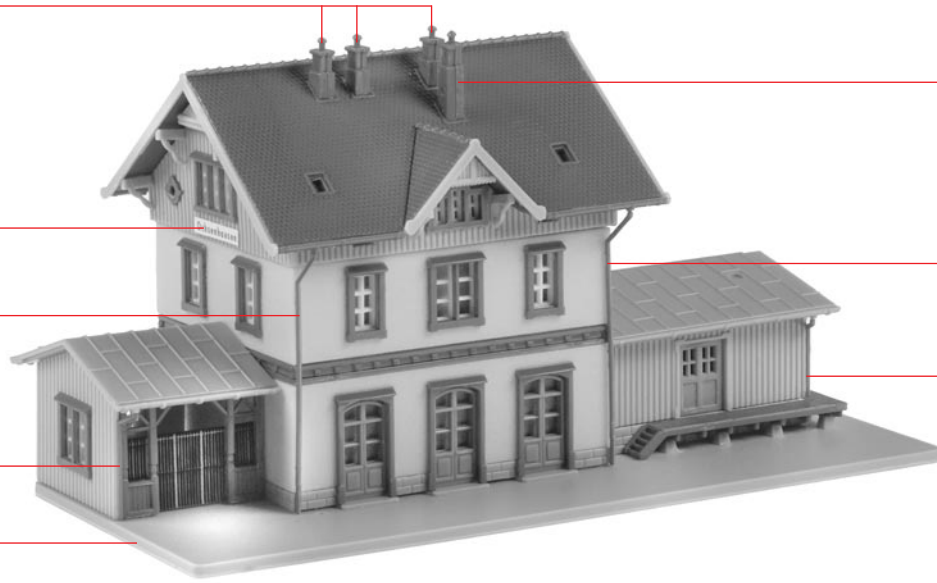

Deco 1

4/26

4/26

4/27

4/23

z

y

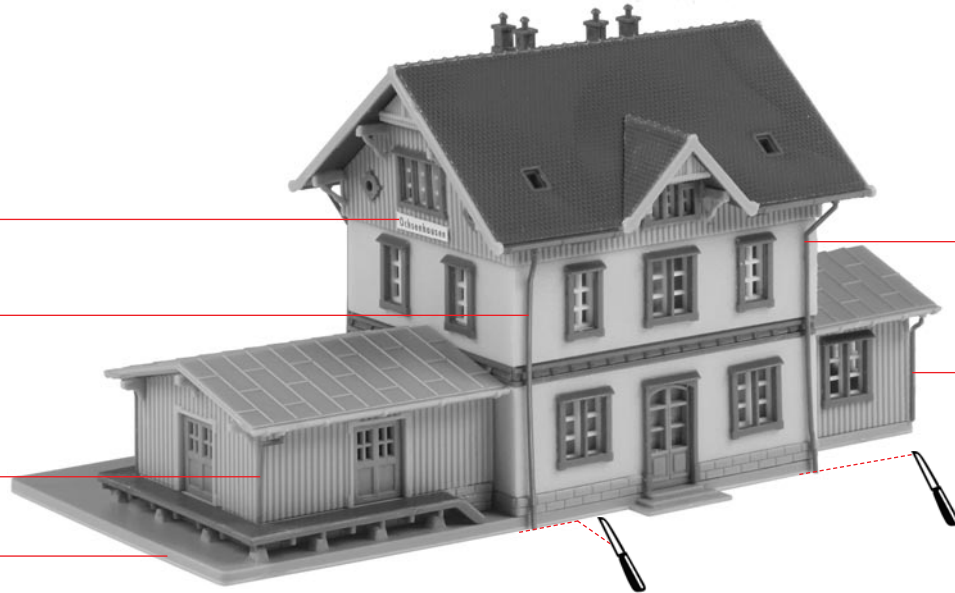

16

1/16

dunkelgrau
dark-grey
gris foncé
donkergrijs

3/21

rotbraun
red-brown
brun-rouge
roodbruin

Z

A

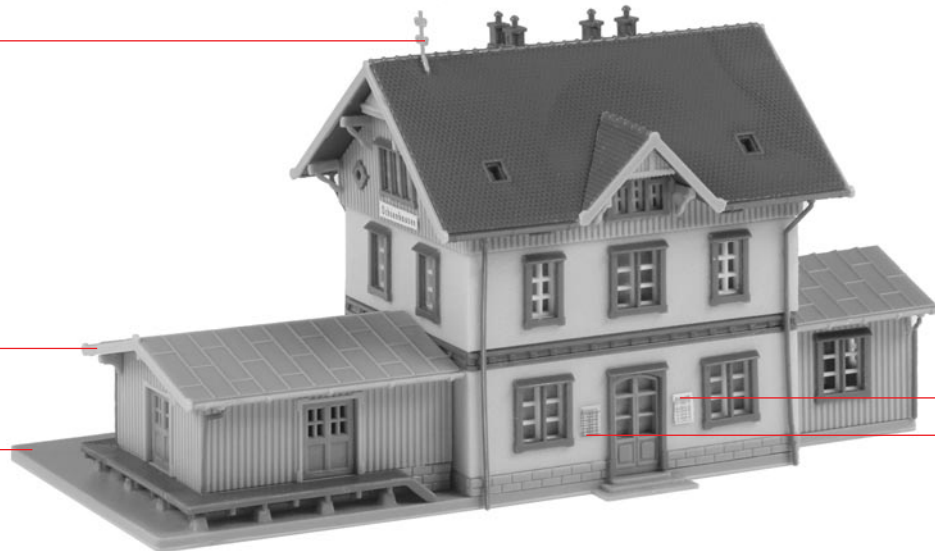

Deco 6

Deco 6

A

3/19

rotbraun
red-brown
brun-rouge
roodbruin

1/13

dunkelgrau
dark-grey
gris foncé
donkergrijs

4/8

B

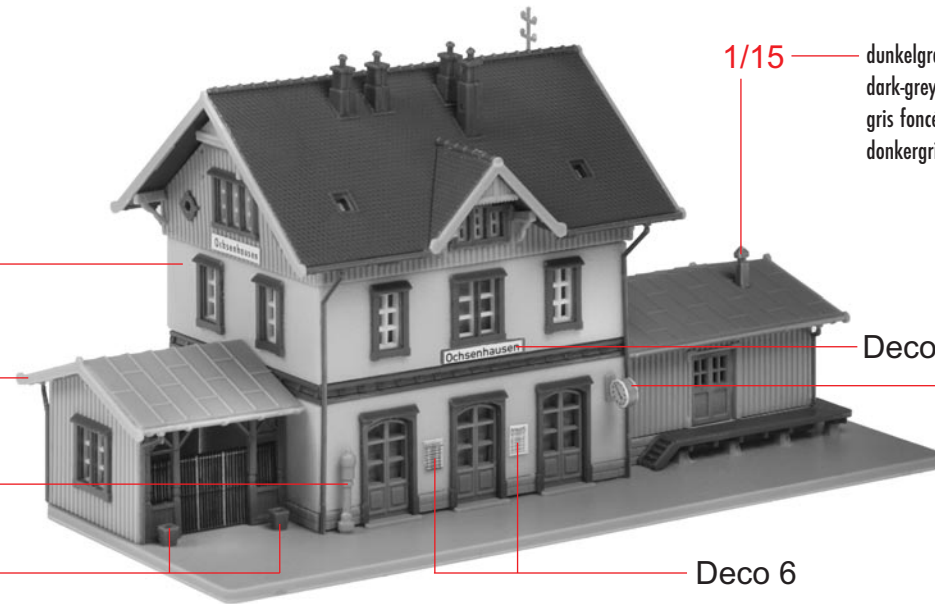

1/15

dunkelgrau
dark-grey
gris foncé
donkergrijs

Deco 1

Deco 6

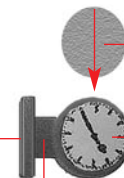

Deco 5

1/14

dunkelgrau
dark-grey
gris foncé
donkergrijs