

37964

Offener Güterwagen Om, Ludwigshafen, DRG, Ep. II

Gondola DRG III · Wagon découvert DRG ep. III

Open goederenwagon DR III

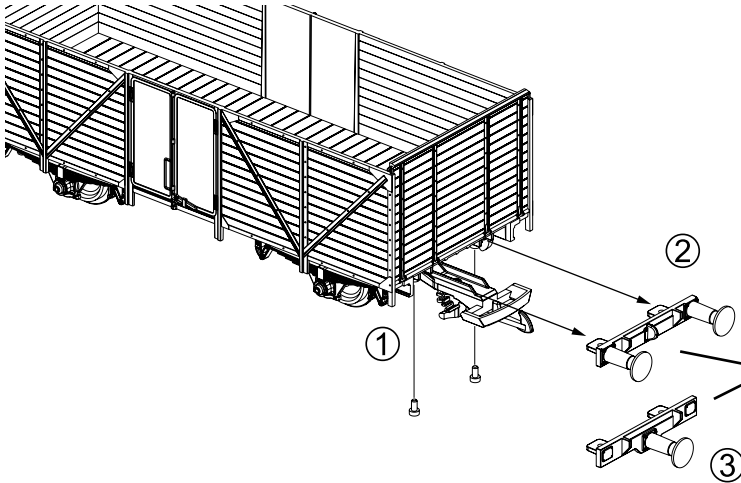

wahlweise: #37600-28
(nicht enthalten)
alternatively: spare part #37600-28
(not included)
au choix: pièce détachée #37600-28
(ne sont pas inclus)
naar keuze: onderdeel #37600-28
(niet inbegrepen)

37964-90-7000

ERSATZTEILE

Spare parts · Pièces détachées · Reserveonderdelen

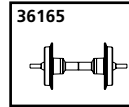
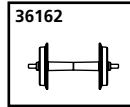
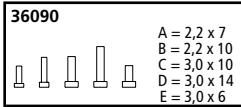
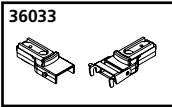
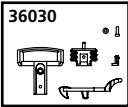
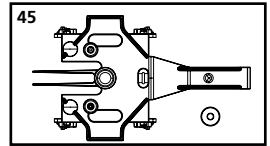
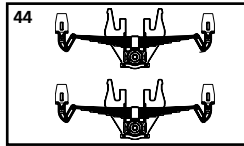
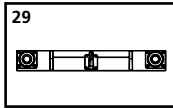
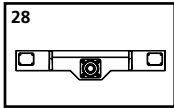
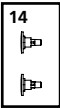

Nr.	Bezeichnung:	Description:	Désignation:	Beschrijving:	PG*
37500-14	Puffer (2 St.)	Buffers (set of 2)	Tampons (2 unités)	Buffer (2 stuks)	6
37600-28	Pufferbohle für Mittelpuffer	End Beam for central buffer	Traverse de tamponnement (tampon central)	Bufferbalk (middenbuffer)	8
37600-29	Pufferbohle für 2 Puffer	End Beam for 2 buffers	Traverse de tamponnement (2 tampons)	Bufferbalk (2 buffers)	8
37900-44	Radblenden	Wheel valence	Flasques à bogies	Wielplaten	10
37900-45	Achshalter	Axle bracket	Support d'essieux	Aslager	10
36030	Standard Ersatzteile	Spare parts, standard range	Pièces détachées standard	Standaardonderdelen	
36030	Kupplung komplett	Standard Coupler	Attelage, complet	Koppeling, volledig	
36033	Ganzzug-Kupplung	Rigid-Coupler	Attelage	Koppeling	
36090	Schrauben-Set (20-tlg./5 Größen)	Set of screws (20 pieces / 5 sizes)	Jeu de vis (20 pièces, 5 tailles)	Set schroeven (20-delig)	
36162	Radsatz Kunststoff 3 St.	Plastic wheel set (set of 3)	Essieux plastiques (3 unités)	Kunststof wielstel (3-delig)	
36165	Radsatz Metall (2 St.)	Metal wheel set (set of 2)	Essieux métalliques (2 unités)	Metalen wielstel (2-delig)	